

# Synchrotron Radiation Sources and Free Electron Lasers

Josef Frisch

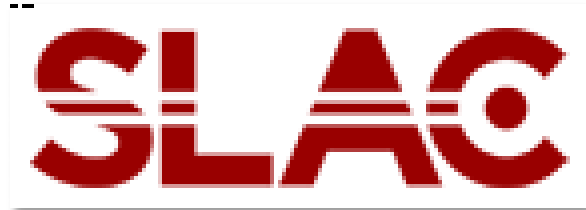

# X-ray Sources

- Modern high intensity sources are based on synchrotron radiation from high energy electrons propagating through an undulator
- This talk will focus on the accelerators and undulator systems that produce the X-rays
  - Typically called “accelerator physics” this is really more like engineering, involving a variety of performance and cost trade-offs.
- This talk will focus on X-ray FELs rather than synchrotron light sources
  - New, rapidly developing technology
  - Much wider variation in types of machines
- Why should X-ray scientists care about the technology:
  - Generally X-ray scientists define the requirements for new sources, it is valuable for them to understand the potential capabilities and limitations of these sources.
  - Understanding the machine capabilities allows the design of better experiments.

# X-ray Beam Parameters

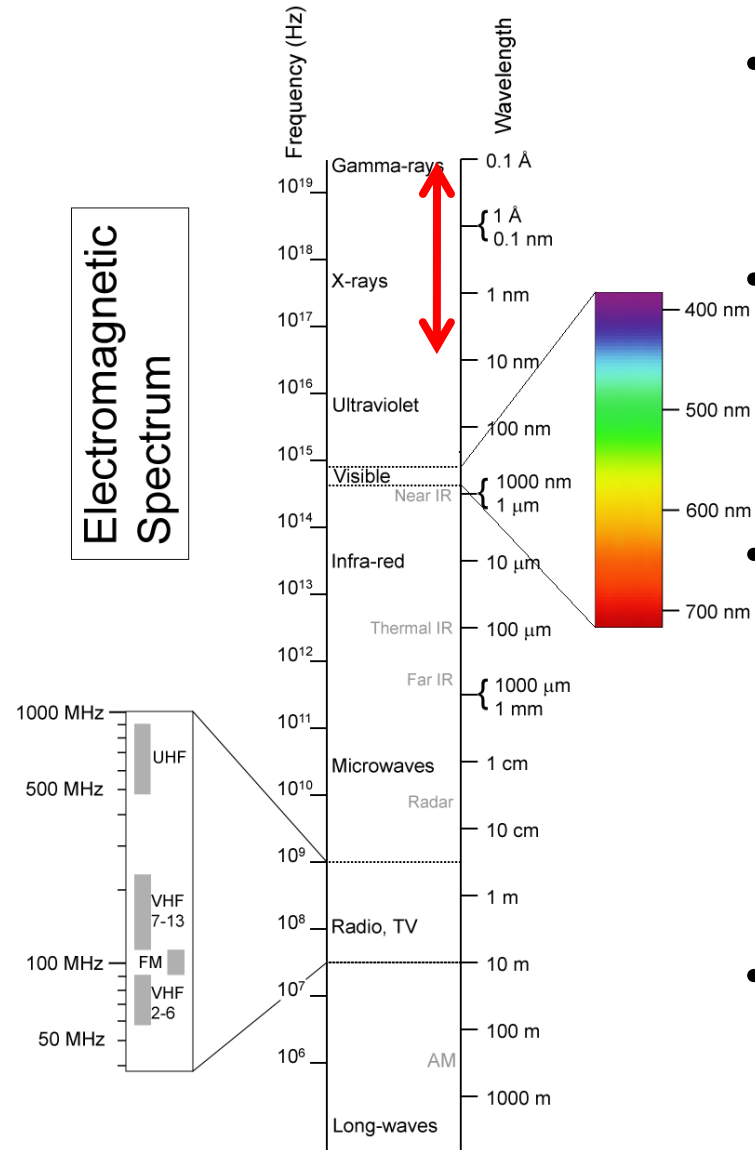

- Energy / Wavelength:
  - $\sim 100\text{eV}$  to  $\sim 100\text{ KeV}$  (12nm to 0.012nm) typical range of interest
    - X1000 Wavelength range
- Pulse structure:
  - Room temperature FEL:
    - 100fs at 100Hz ( $10^{-11}$ ) duty factor
  - Storage rings
    - $\sim 3\text{ps}$  at 300MHz ( $10^{-3}$ ) duty factor
- Linewidth
  - Typically 0.1% to 1% at source, monochromators used to reduce linewidth for experiments.
  - Synchrotron sources typically have a large harmonic content
  - Future seeded FELs and oscillators may have much narrower linewidths.
- Beam transverse phase space ( $\Delta x \Delta x' \Delta y \Delta y'$ )
  - Limited by diffraction limit at the operating wavelength

# Brilliance

Photons / (sec·mrad<sup>2</sup>·mm<sup>2</sup>·0.1%bw)

- Peak brightness: within a pulse
- Average brightness .
- Often used to compare light sources, but need to consider the requirements of specific experiments.
- For experiments where the output signal is linear in photon flux, and where backgrounds are not a problem mostly care about “average” brilliance
  - Can take data over many pulses
  - Example: Measuring writing in a 1000 year old manuscript.
- Nonlinear experiments, or experiments where the target is destroyed by each pulse primarily rely on “peak” brilliance
  - Example: Destructive imaging
- If the experiment acceptance is wider than the light source, brilliance is no longer an important criteria.



Archimedes Manuscript read at SSRL / SLAC - Average Brilliance Required (Uwe Bergmann et al)  
Photo by Diana Rogers

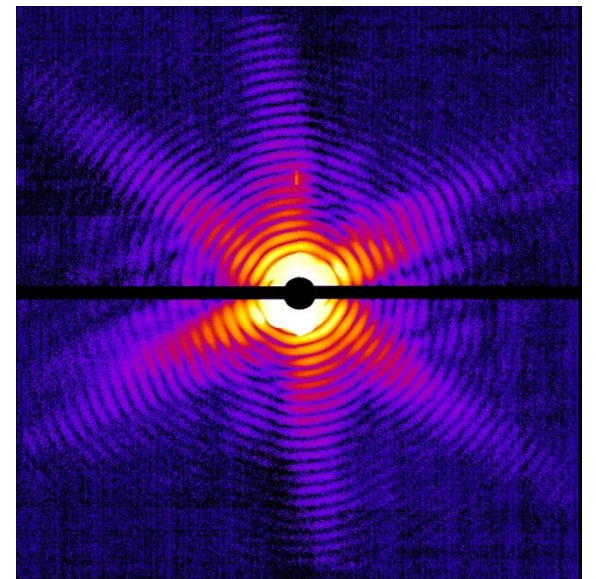

Mimivirus diffraction pattern at LCLS / SLAC  
Peak Brilliance Required (M. Seibert et al)

# Focusing X-ray Beams

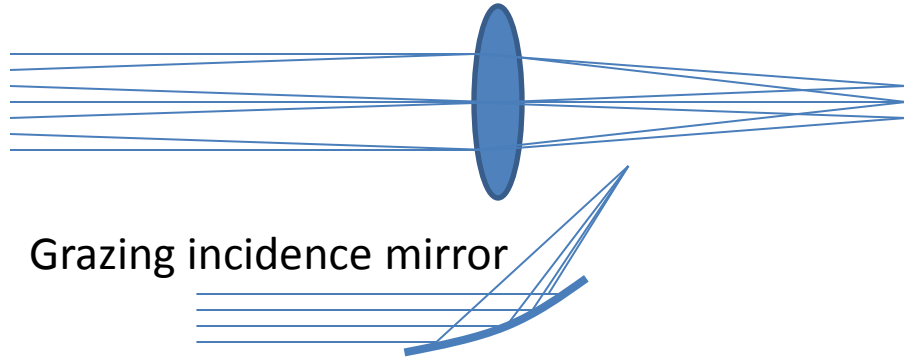

Lens (or mirror) has limited bending angle  $\alpha$   
 This limits the focal length,  $f \sim x / \alpha$   
 Uncorrelated angular spread limits focal size  $w \sim x' \cdot f$   
 Spot size  $w \sim x \cdot x' / \alpha$ , goes as transverse phase space.

Grazing incidence mirror

- Grazing incidence X-ray mirrors
  - Maximum reflection angle depends on X-ray energy
  - For Silicon: 1 kV  $\rightarrow$  1.7 degrees, 12 kV  $\rightarrow$  .15 degrees
  - Maximum practical mirror size  $\sim$ 1M, limits maximum input beam size, and number of mirrors
- Be Lens:
  - Index of refraction  $<$  1, can be used to make a refractive lens.
  - Multiple lenses can be used at high photon energies
- At 1kV
  - Silicon reflection angle  $\sim$ 1.7 degrees
  - Be bend angle 1.52 degrees, Absorption length 9 microns (IMPRACTICAL).
- At 12 kV
  - Silicon Reflection angle 0.15 degrees
  - Be bend angle .125 degrees absorption length 1.4cm (MULTIPLE  $\sim$ 10 LENSES POSSIBLE).
- Beam brightness (may be diffraction limited) limits spot focus

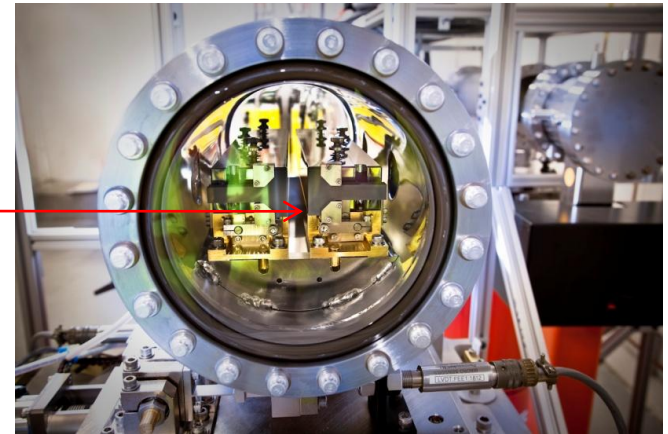

SLAC / LCLS

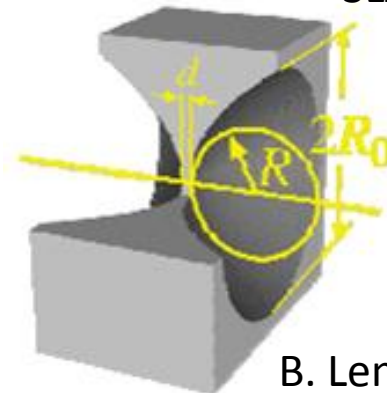

B. Lenegeler

# X-ray longitudinal phase space

- X-ray experiments often use monochromators to reduce the line width from the source.
  - In this case reduced source linewidth directly increases the photon flux to the experiment.
- Nonlinear experiments (like creating multi-core holes) require high peak power
- Time resolved measurements require short pulses.
- Radiation of course must be transform limited – most sources not near this limit yet.

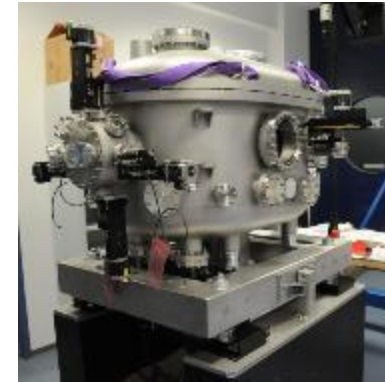

SLAC / LCLS SXR monochromator  
 $2 \times 10^{-4}$  Bandwidth at 1 KeV

L. Young et. al.  
LCLS / AMO

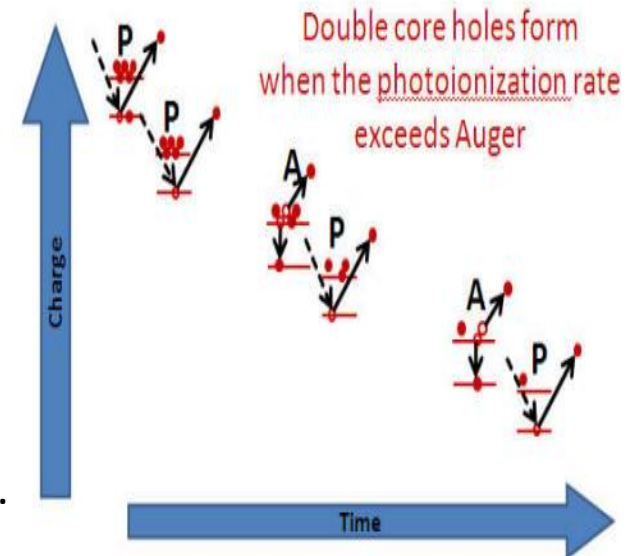

# Undulator Radiation

Most high brightness X-ray sources rely on undulator radiation  
(synchrotron radiation from bends also used in storage rings)

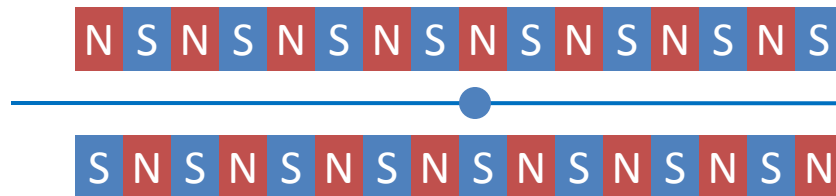

Relativistic electron moves in alternating magnetic field

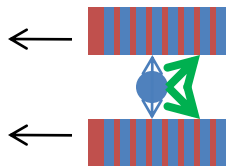

In the average co-moving frame of the electron the undulator wavelength is shortened by gamma.

Normalized field strength 
$$K = \frac{eB\lambda_u}{2\pi m_e c}$$

In weak fields ( $K < 1$ ), motion is sinusoidal, no harmonics

In strong fields ( $K > 1$ ) motion is relativistic in the co-moving frame. This produces nonlinear motion and harmonics.

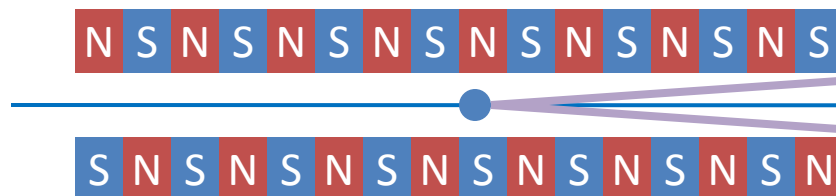

In the lab frame, the radiation wavelength is Doppler shifted by another factor of gamma.

# XFEL Electron Beam Parameters

- Energy: typically 1-20 GeV, beams are ultrarelativistic ( $\gamma \gg 1$ )
- Energy spread typically  $< 0.1\%$  (except in bunch compressors).
- Bunch length: few femtoseconds to a few picoseconds (microns to millimeters)
- Beam transverse sizes:  $\sim 100$  microns
- Emittance: Product of RMS size and uncorrelated RMS angular spread
  - $\epsilon_x = \pi \cdot \delta x \cdot \delta x'$ , usually quoted in “pi millimeter milliradians”, or “microns”.
  - Invariant with linear focusing optics
  - Normalized emittance  $\epsilon_n = \epsilon \cdot \gamma$  is also invariant with acceleration.
  - Typical normalized emittances  $\sim 1 \mu\text{m}$ .
  - For FELs need emittance  $\leq \lambda / (4\pi)$ ,
    - 1  $\mu\text{m}$  emittance,  $\gamma = 20,000$  (10 GeV)  $\rightarrow 3 \text{ \AA}$

## Relativity

- Lab frame
  - synchrotron beams are fairly long (several mm long, 100  $\mu\text{m}$  wide).
  - FEL beams are  $\sim$ spherical (30  $\mu\text{m}$  long and wide).
  - FEL undulator is 100M long
  - Microbunching: 1  $\text{ \AA}$  bunches in a 50  $\mu\text{m}$  transverse size beam ( $5 \times 10^5 : 1$ ) (!!!)
- Beam frame: ( $\gamma = 10^3 - 3 \times 10^4$ )
  - Beams are much longer ( $\sim 1\text{M}$ ) than they are wide ( $\sim 50 \mu\text{m}$ ).
  - Undulator is  $\sim 3\text{mm}$  (shorter than the electron bunch!).
  - Microbunching is 3  $\mu\text{m}$  in a 50  $\mu\text{m}$  beam, 15:1, not so extreme.



# Accelerators

## Synchrotron

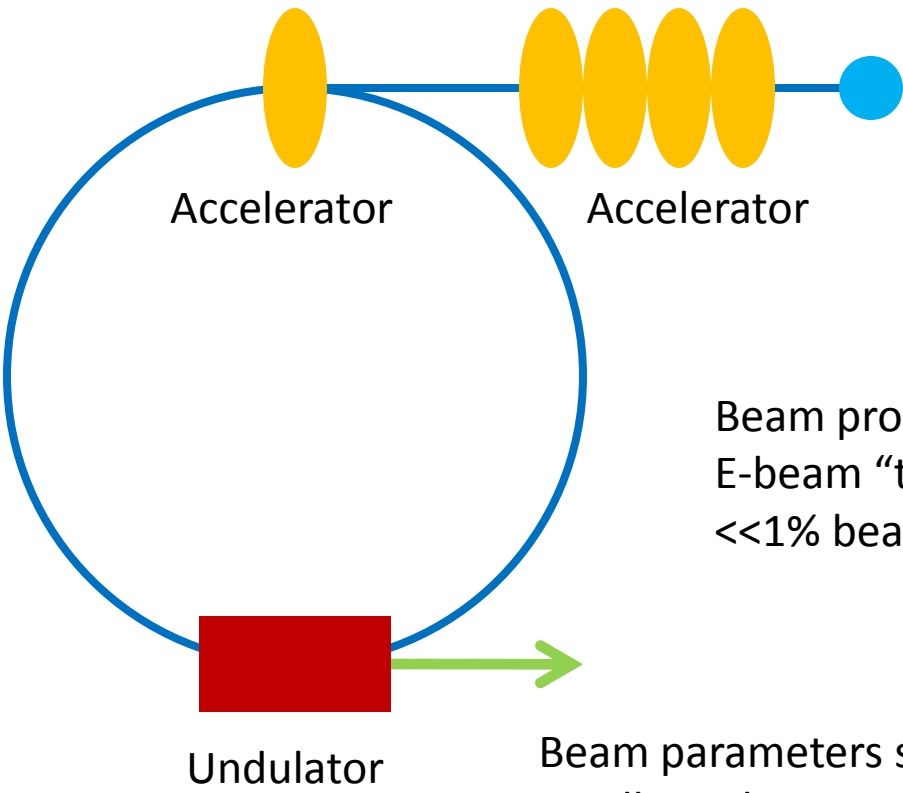

## LINAC

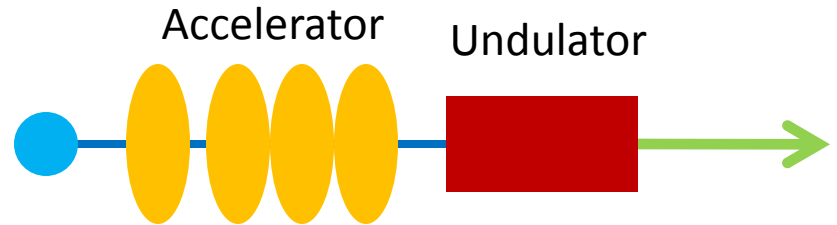

Beam properties mostly determined by the injector.  
E-beam "thrown away" after undulator  
<<1% beam energy used

Beam parameters set by equilibrium conditions  
Small accelerator replaces beam energy lost by X-ray production

# Synchrotrons

- Synchrotrons recirculate beams with RF only needed to restore energy lost to synchrotron radiation
  - High pulse rate ( $\sim 100\text{MHz}$ )
  - High average current ( $>100\text{mA}$ )
  - Most RF power goes to producing X-rays (but maybe not in a usable phase space).
- Synchrotron radiation
  - Cools beam: higher energy electrons emit more radiation.
  - Heats beam: statistics in emission of X-ray photons
- Beam reaches equilibrium temperature
  - Vertical emittance is very good:  $\sim 0.03\mu\text{m}$  normalized
  - Horizontal emittance larger  $\sim 3\mu\text{m}$
  - Longitudinal phase space typically 0.1% BW X 15ps bunch
  - Can be described in emittance units as  $\sim 10^4\mu\text{m}$ .
- **Longitudinal phase space too large for X-ray FELs (LINAC  $\rightarrow 5\mu\text{m}$ , not 10,000)**
- $>75$  light sources worldwide!
- $>\$200\text{M}\text{€}$  for large rings (and up!)



# Light Source: Petra III at DESY

- Parameters
  - 6 GeV
  - 2304 M Circumference
  - 100mA average current
  - 960 bunches / 8ns, or 40 bunches, 192ns
- Very low emittance: 1nm (geometric), (~10um normalized).
- Highest brightness existing synchrotron source

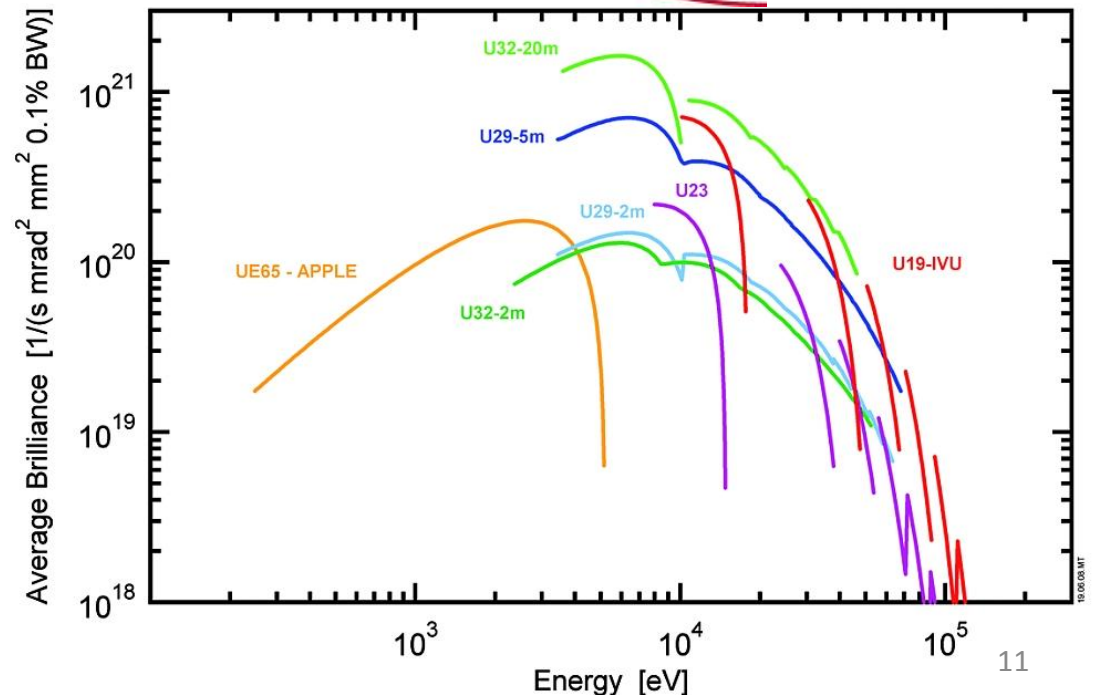
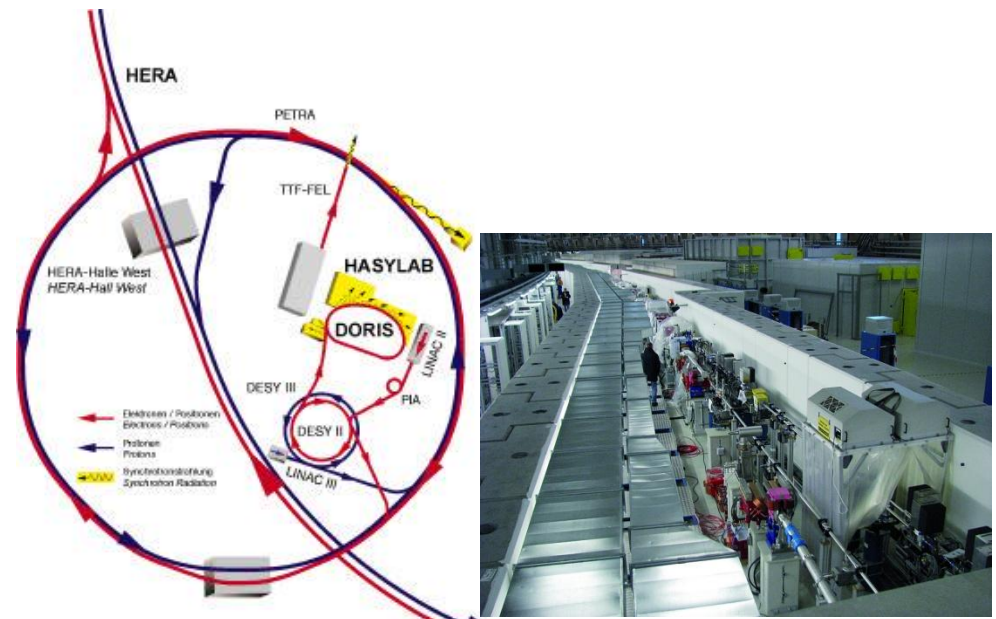

# “Ultimate” Storage Rings

High energy, low emittance rings.

Small beam size in undulator can result in diffraction limited X-ray beam  
 -> “ultimate”.

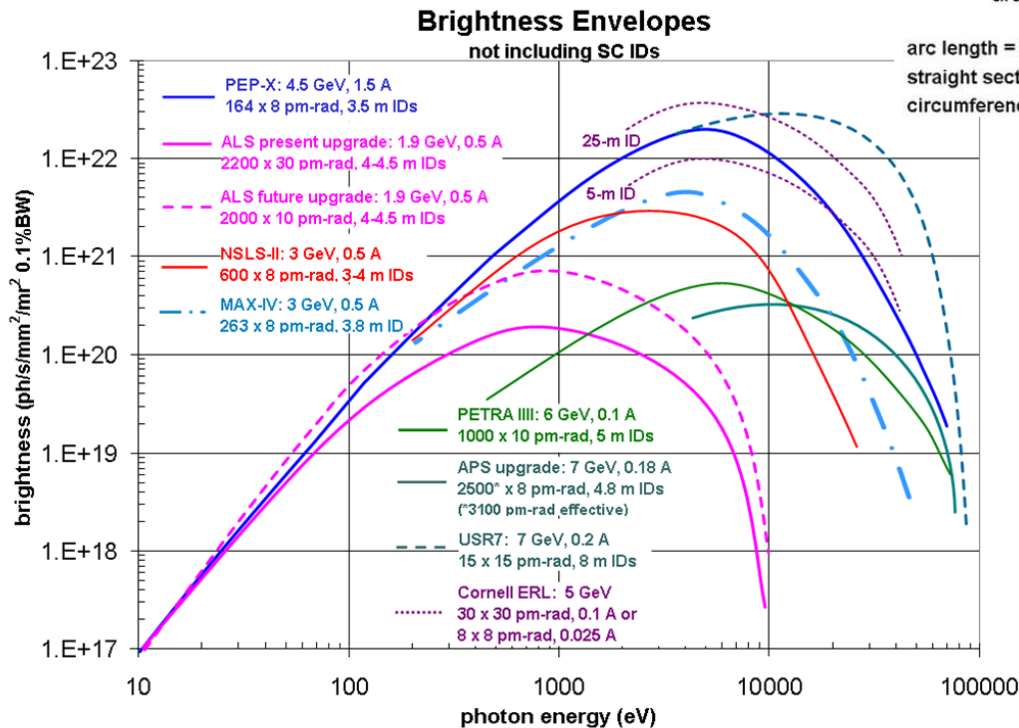
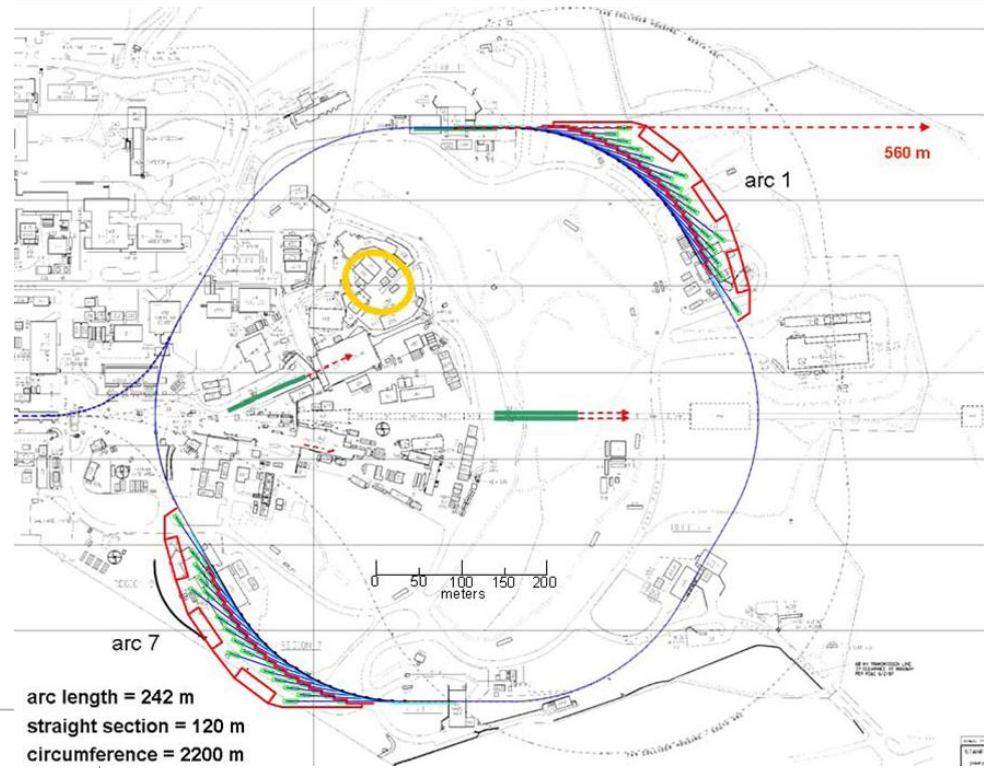

Proposed at various facilities:

## SLAC PEP-X design:

- 4.5 GeV, 2200M circumference
- 1.5A average current (12MW RF!)
- Ultra-low emittance lattice

Average brightness  $3 \times 10^{22}$   
 Peak brightness  $\sim 10^{25}$

# LINACS

- Single pass devices
- Low repetition rate, low average current
  - Room temperature  $\sim 100\text{Hz}$
  - Superconducting 10KHz to 1MHz average
- Beam emittance primarily determined by the electron source
  - Typically  $1\mu\text{m}$  in horizontal and vertical
  - Longitudinal phase space excellent ( $5\mu\text{m}$ )
- Can be used for FELs



# High Brightness Electron Sources

The beam phase space will not decrease after the electron source: A high brightness source is critical for LINAC based FELs.

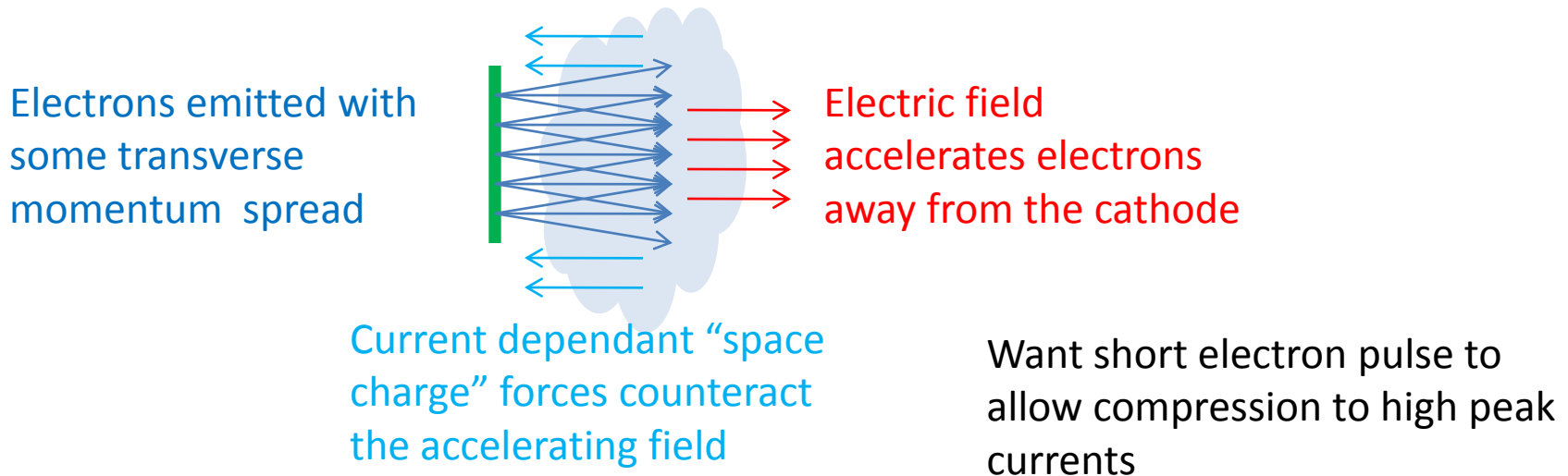

Emittance  $\sim$  radius X transverse energy spread

Minimum cathode radius set by space charge limit  $\rightarrow$  want as high a gradient as practical

Want minimum transverse momentum spread (cold beam).

Surface roughness can increase transverse momentum spread, want  $< 10$ s of nanometers.

# Electron Guns

RF guns used at SLAC and most proposed XFELs  
RF cavities can support very high fields (120MV/M for LCLS)  
Short pulse ( $\sim$ picosecond) laser to generate photo-electrons

Low repetition machines (LCLS 120Hz) typically use copper cathodes, low QE ( $3 \times 10^{-5}$  @260nm), but high gradient

High repetition rate superconducting machines may use higher QE ( $\text{Cs}_2\text{Te}$ ,  $\sim 10\%$  at 260nm) cathodes to reduce laser power (may require reduced gradient)

RF GUN:  $0.5 \pi\text{mm-mr}$  measured at 250pC

Pulsed DC (500kV, 3 $\mu$ s, 10MV/M) gun used at SCCS and SACLA at Spring-8.

Thermal emission from heated cathode to produce beam.

$0.7 \pi\text{mm-mr}$  measured at 300pC

**NOTE: emittance measurements not directly comparable due to different bunch lengths!**

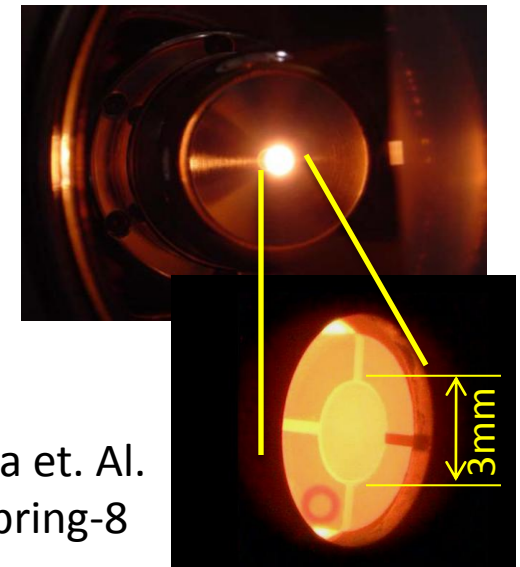
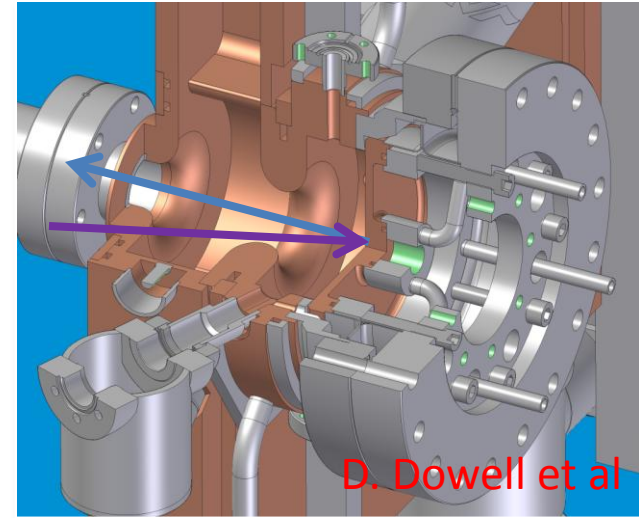

# Accelerators

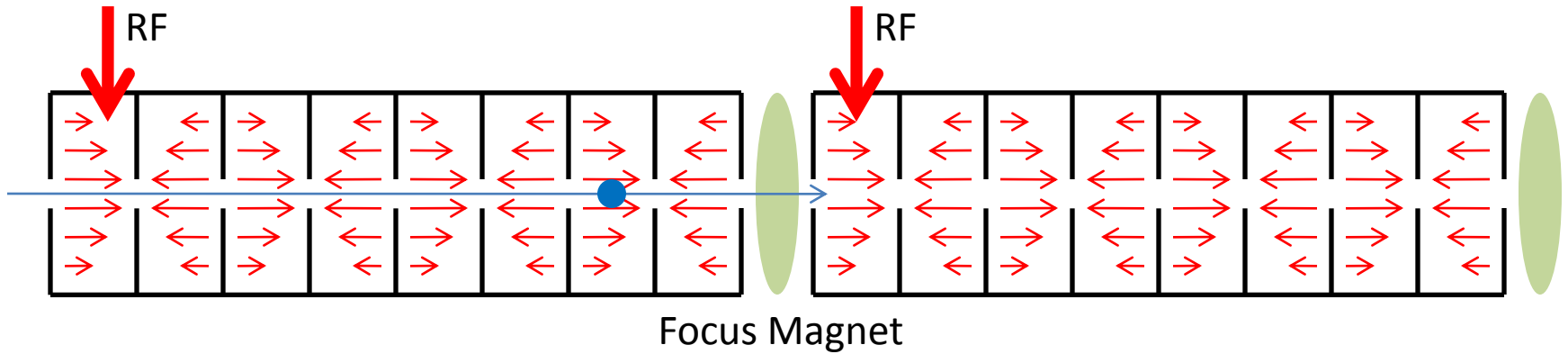

Accelerators use a series of resonant cavities (typically 1-10GHz) driven by a high power RF source.

The electron bunch timing and the phases of the cavities are adjusted so that the electrons are accelerated in each cavity in sequence

Alternating focus and de-focus magnets (can't focus in both planes!) provide average focusing for the electron beam.

Off axis beam trajectories will excite higher modes and produce wakefields that can disrupt the beam – can need  $\sim 100\mu\text{m}$  tolerances on beam orbit.

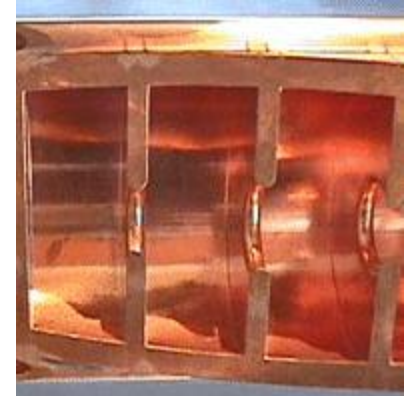



# Pulse Structures

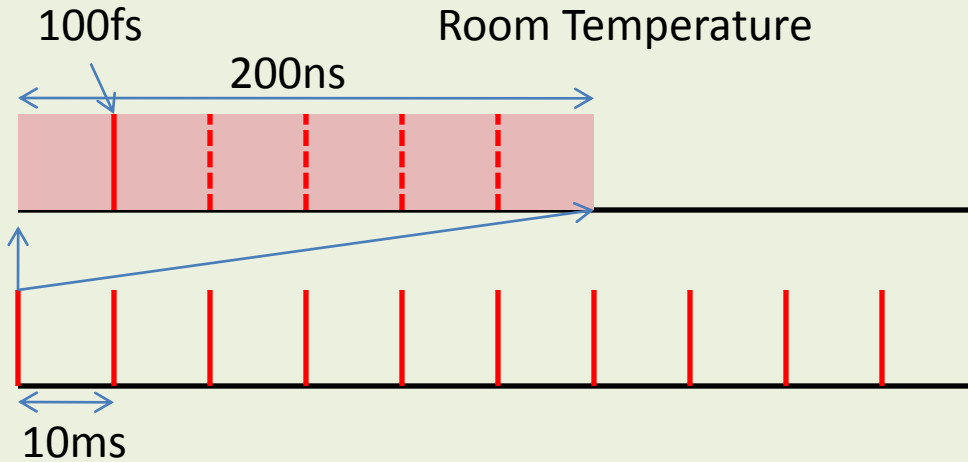

100fs electron bunches

~200ns RF pulses, typically 1 but can contain multiple (<100) bunches

~100Hz overall repetition rate

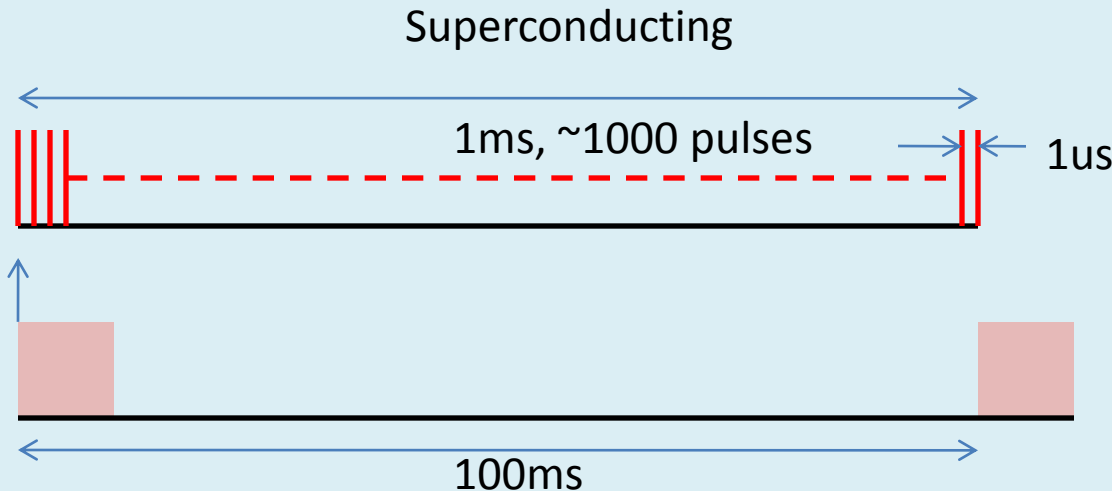

100fs electron bunches

1ms RF pulses, typically 1000 bunches at 1MHz

$10^4$  Hz overall repetition rate

CW superconducting machines can have  $10^6$  Hz overall repetition rate

# Room Temperature and Superconducting Accelerators

## Room Temperature

- RF pulse energy fills the cavity volume with fields
- Typically operate with short ( $\sim 1\mu\text{s}$ ) pulses
  - Power goes as gradient squared
- High frequency cavities
  - Higher breakdown voltage (very roughly as  $f^{1/2}$ )
  - Less RF power  $\sim f^2$  for the same gradient
  - Tighter tolerances on machining and beam orbit
  - More difficult RF sources
- SLAC (1960s) 3 GHz, 17MV/M
- SACL (2011, Spring-8), 6 GHz, 35MV/M
- X-band test accelerators (SLAC, NLCTA), 12GHz, 70-100MV/M

## Superconducting

- Majority of RF power absorbed by the beam
  - Typically much higher efficiency than RT accelerator.
- Typically operate with long: 1ms pulses.
  - Can run CW at lower gradient.
- RF power absorbed by cavities must be removed at cryogenic ( $\sim 2^\circ\text{K}$ ): **Very expensive heat!**
- Cryogenic losses go as  $\sim$ gradient squared
- Operating gradients  $\sim 24\text{MV/M}$
- Test cavities operate at 32-45MV/M

SC accelerators are more expensive per GeV than RT accelerators (maybe X2??). Continuous beam SC accelerators are another factor of  $\sim$ X2 more.

# Bunch Compression

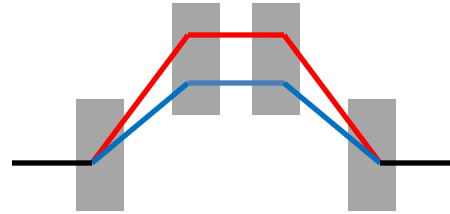
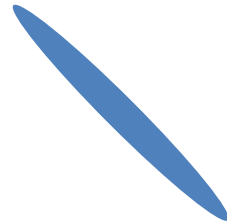
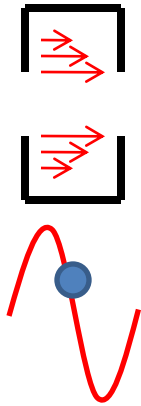
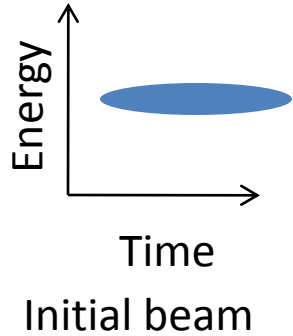

Magnetic Chicane: Higher energy particles follow a shorter path. This allows the tail to catch the head of the bunch.

Typically operate at slightly less (or more) than full compression

Accelerator structure operated off crest. Tail of beam gains more energy than head

Note: beams are ultra-relativistic , can't compress at high energy without a bend

Typically use 2 or 3 bunch compressors to improve tolerances: LCLS Shown

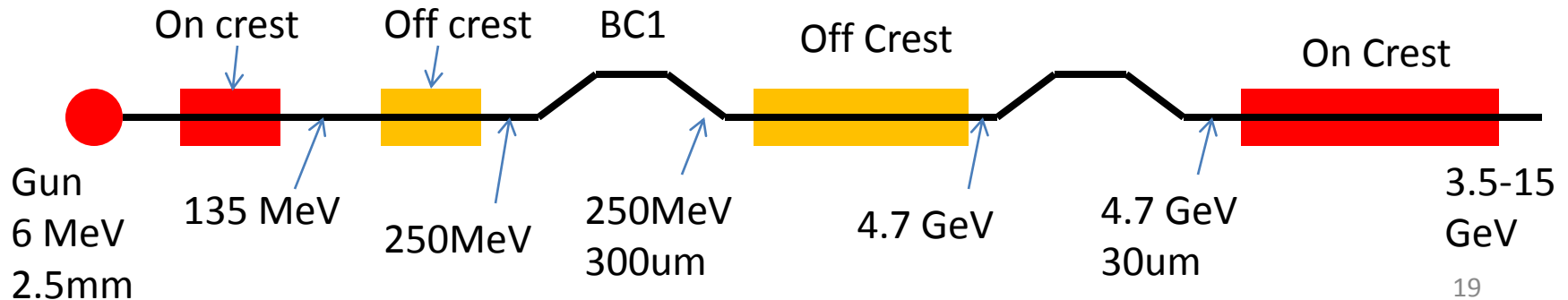

# Bunch Compression – Harmonic structure for linearization

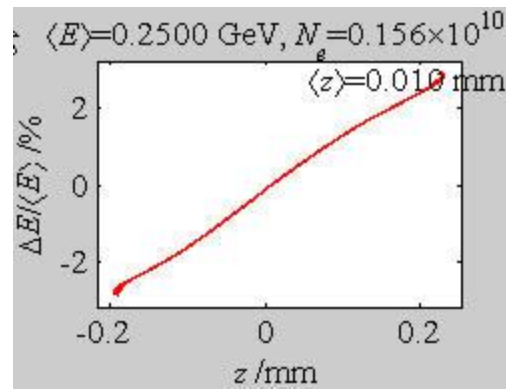
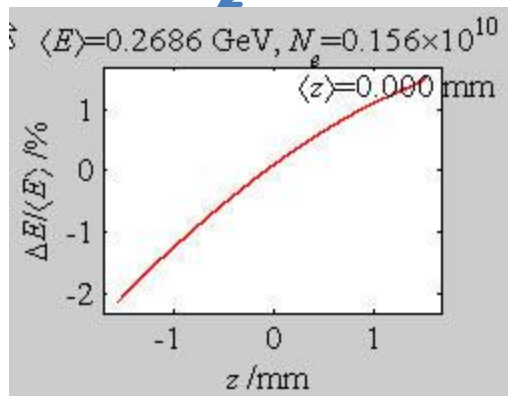
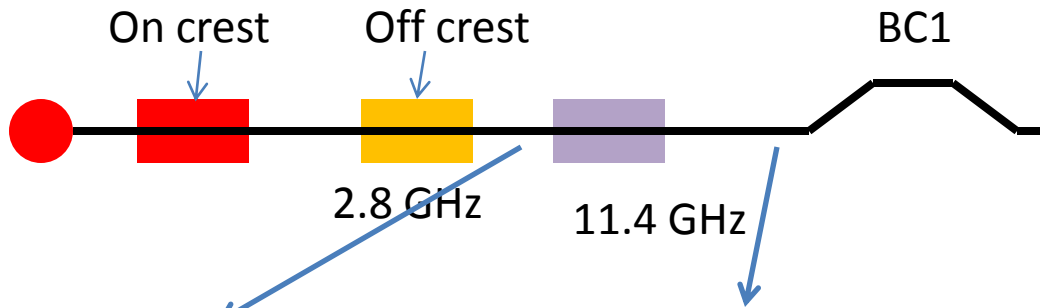

Use of harmonic RF eliminates first order curvature

Greatly improves final electron pulse shape

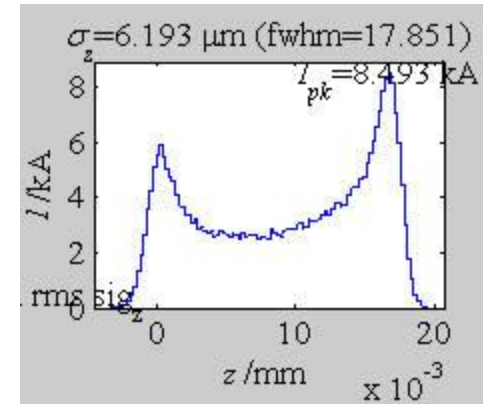

Bunch shape with harmonic compression

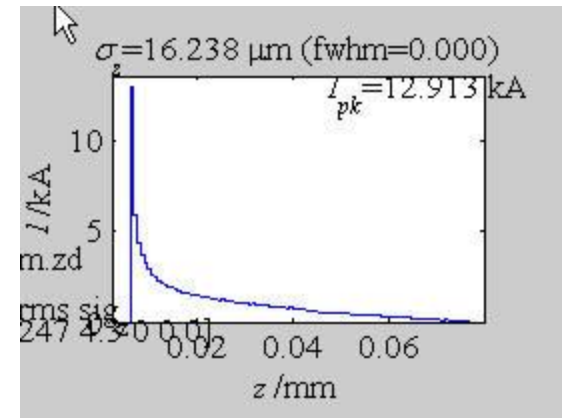

Bunch shape with no harmonic compression

# Bunch Compression - Wakefields

- When an electron bunch propagates through a LINAC it generates “wakefields”.
- Transverse wakes can kick the tail of the bunch relative to the head.
  - This is a problem as it can cause emittance growth
  - Minimized by keeping beam centered in the structure
- Longitudinal wakes decelerate the tail of the bunch.
  - This is actually an advantage: Can cancel the energy chirp put on the beam for compression.

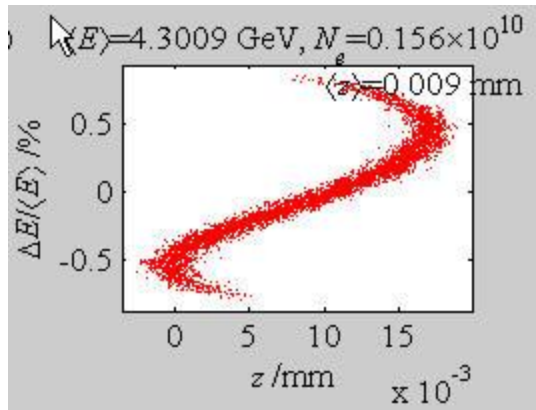

LCLS, After second  
bunch compressor  
 $\Delta E/E = 0.4\%$

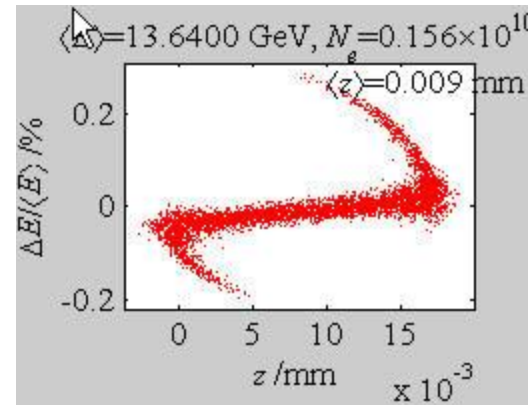

LCLS at undulator  
 $\Delta E/E = 0.06\%$

Longitudinal wakes much smaller in superconducting linacs:  
Need to limit chirp and have larger bunch compressor  
Puts more stringent requirements on RF stability

# CSR Emittance Growth

- FELs have higher gain and better efficiency with higher peak currents.
- Coherent Synchrotron Radiation causes emittance degradation in bends for high peak currents

Synchrotron radiation grows dramatically at wavelengths longer than the bunch length

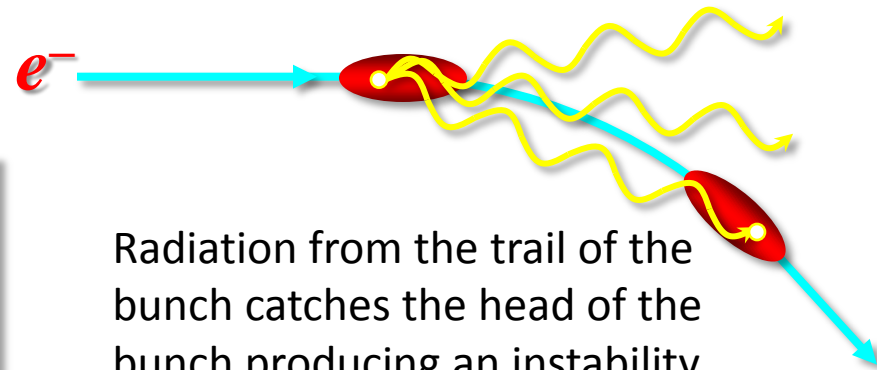
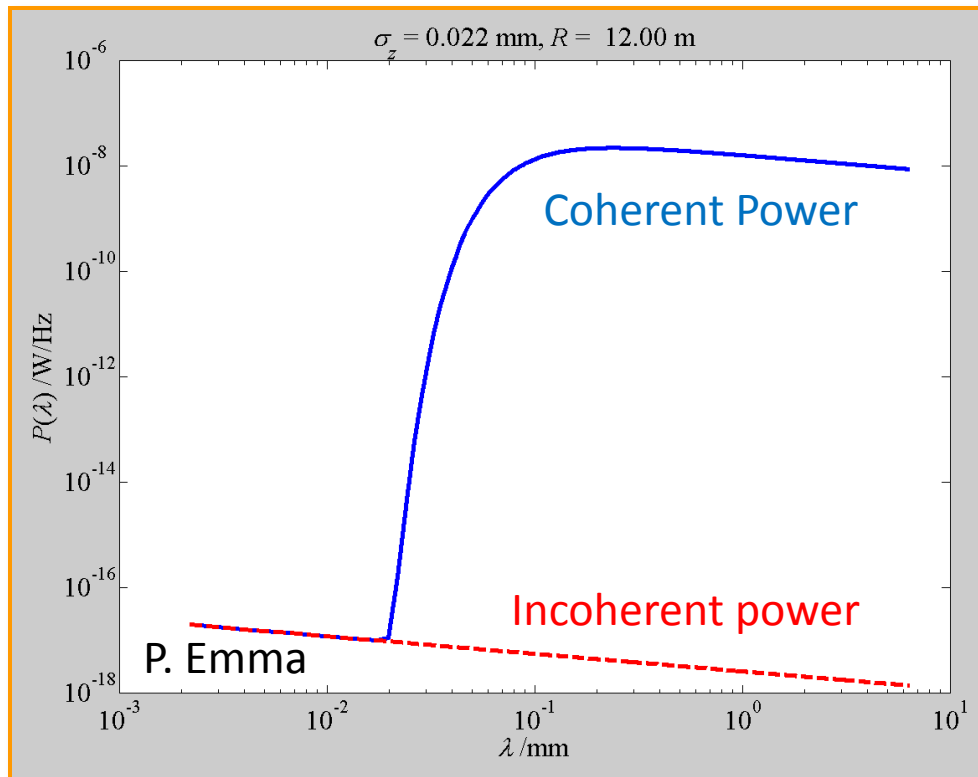

Radiation from the trail of the bunch catches the head of the bunch producing an instability

Bunch compressors limited to peak currents of a few KA for reasonable parameters.

Improvements would be very valuable for future FEL projects.

# FELs: Gain and Coherent Emission

- Synchrotron light sources produce incoherent radiation
  - Electron positions are not correlated at X-ray wavelengths
  - X-ray phase produced by each electron is random
  - Fluctuations in the electric field go as  $N^{1/2}$  so power goes as  $N$
  - X-ray power linear in number of electrons
- In an FEL the electrons are bunched at X-ray wavelengths
- These bunches can then radiate in phase, field goes as  $N$ , power as  $N^2$  until beam is fully bunched, then power saturates
- Gain depends on peak current
- If electron beam phase space (emittance and energy spread) is too large, the bunching required for gain will be washed out.
  - X-ray FELs place very stringent requirements on the electron beam.
- A FEL CAN be described in a quantum-mechanical formulation to look like a laser, but this is not necessary or convenient for any proposed FELs. Much more intuitive to consider as a fully classical system.

# Klystron (Microwave tube) as a model of FEL gain mechanism

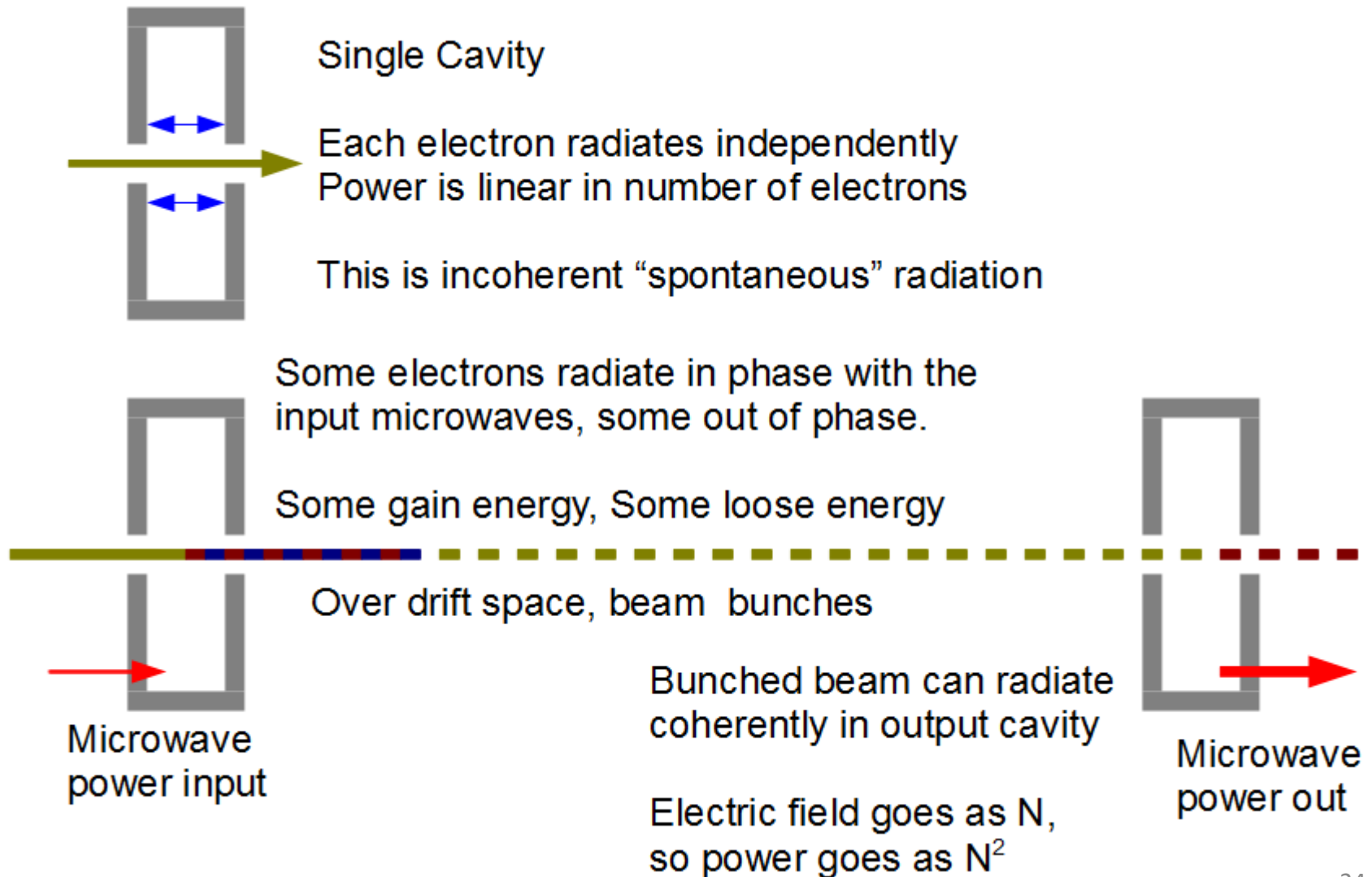



# Undulator as emission mechanism

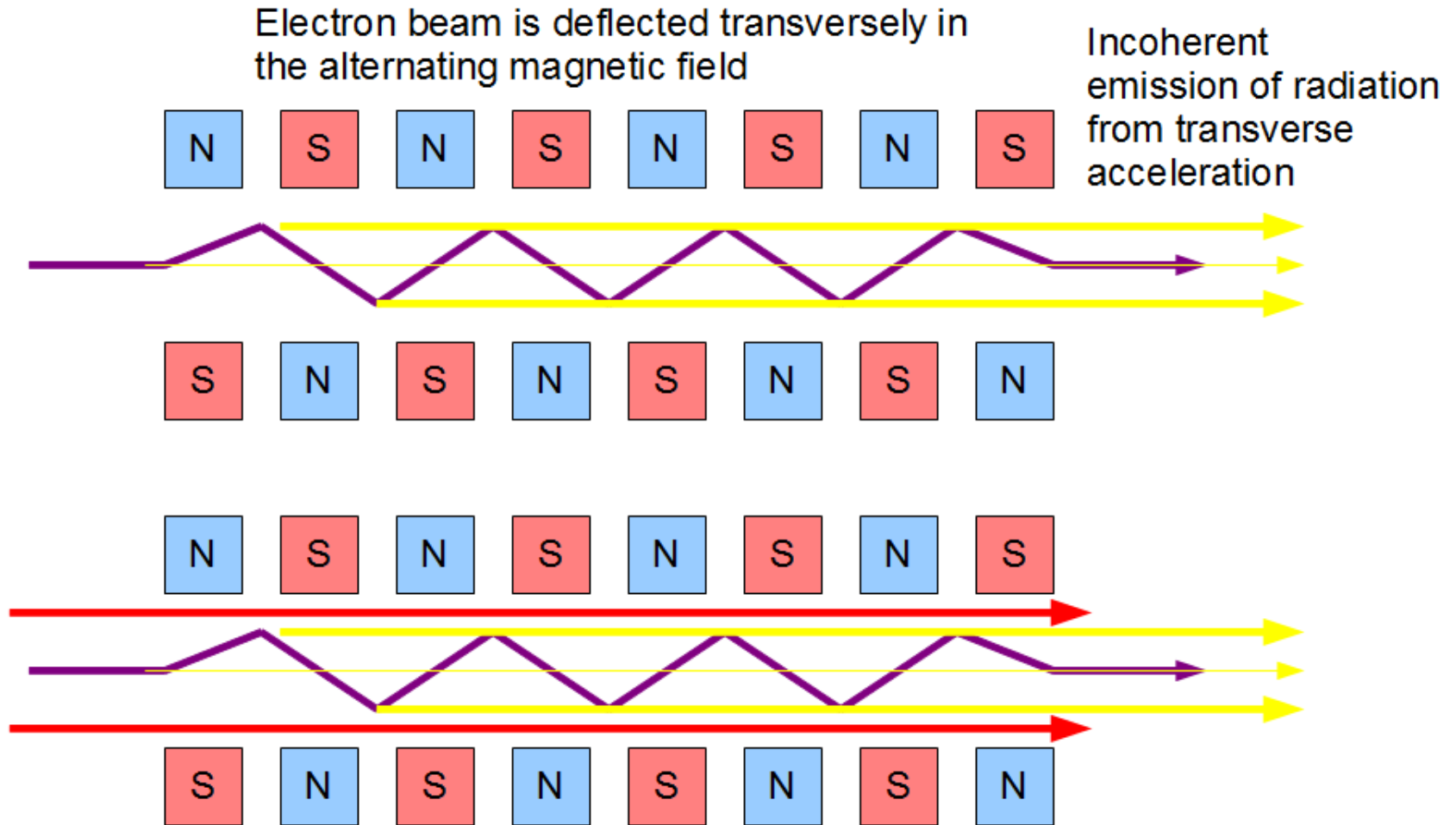

Input electromagnetic radiation at same frequency as emitted spontaneous radiation. Some electrons emit in phase, some out of phase, thereby gain or lose energy

# FEL Process

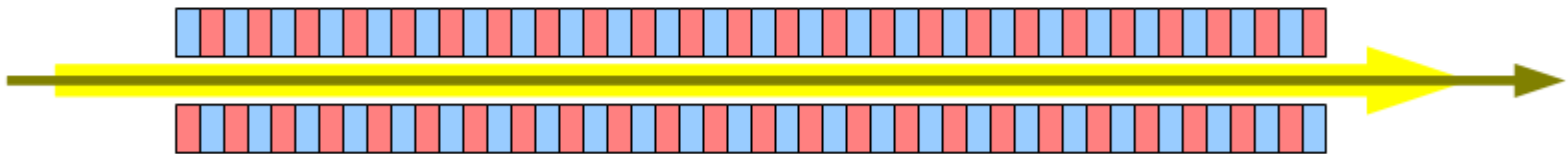
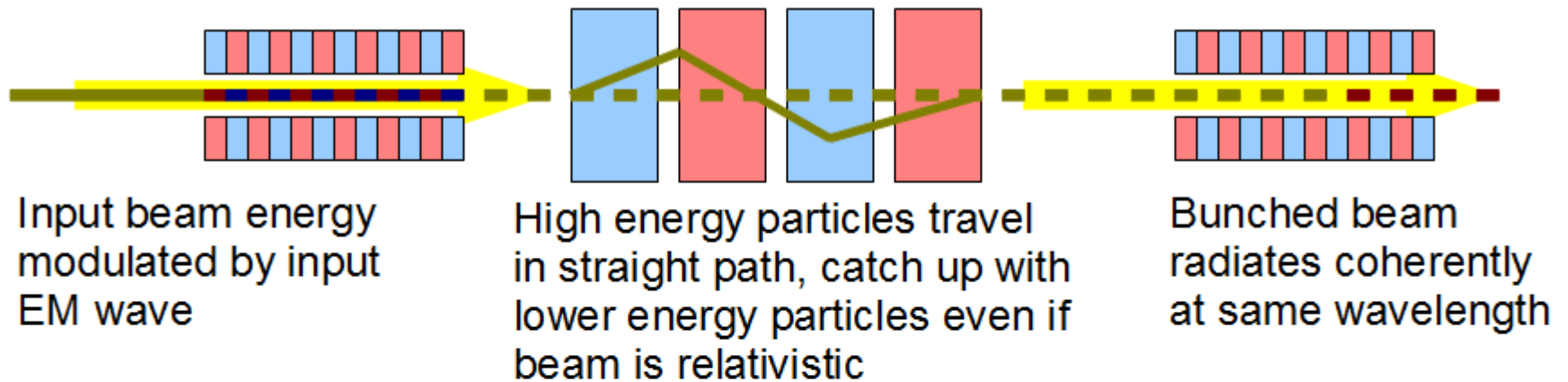

For typical FEL this is a continuous process of bunching, and emission, but concept is the same.

# Self Amplified Spontaneous Emission

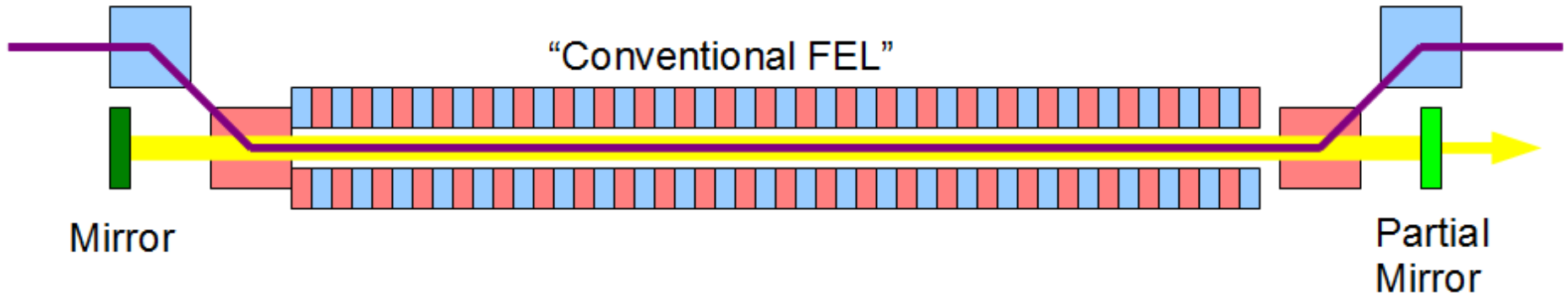

Mirrors not practical at wavelengths below about 200nm.



Spontaneous emission from early part of undulator is amplified in later part.  
Spectrum is not a narrow as for a laser, intensity can be very high.

# Brilliance Comparison

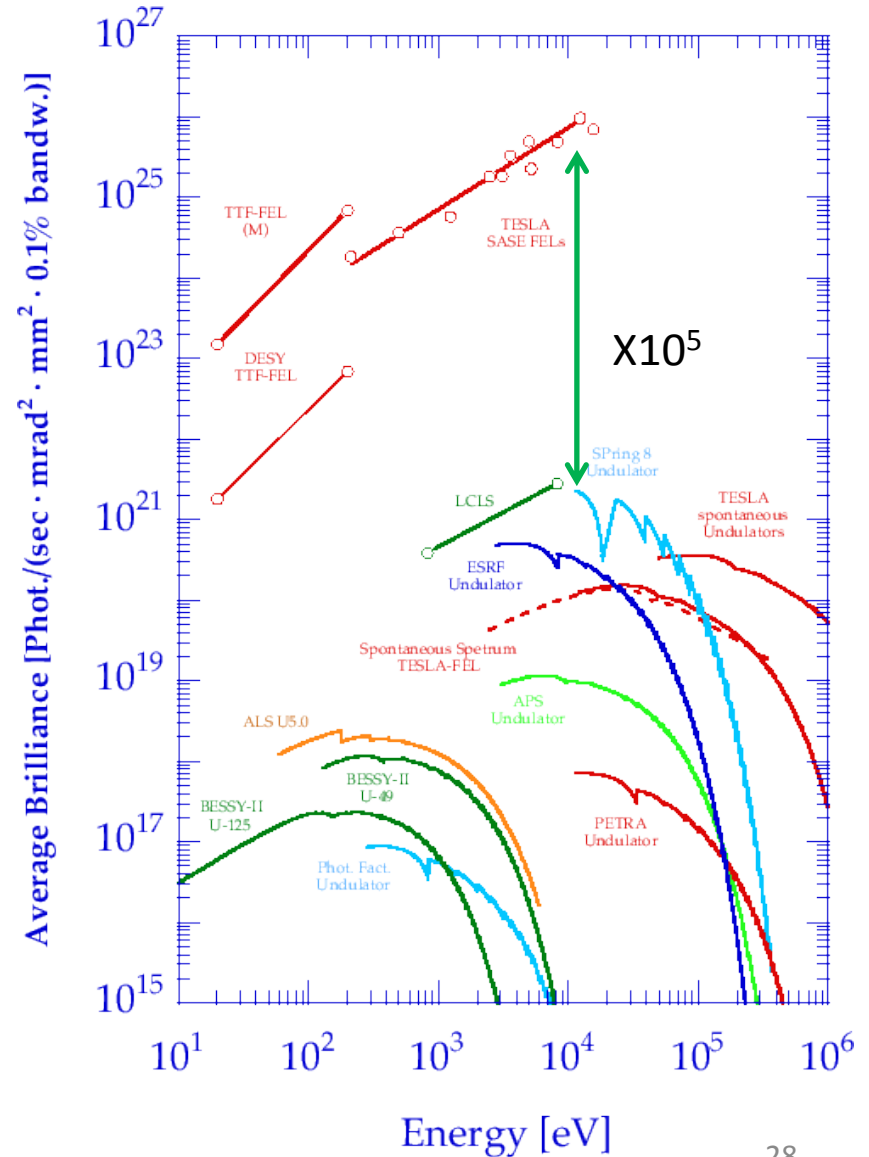
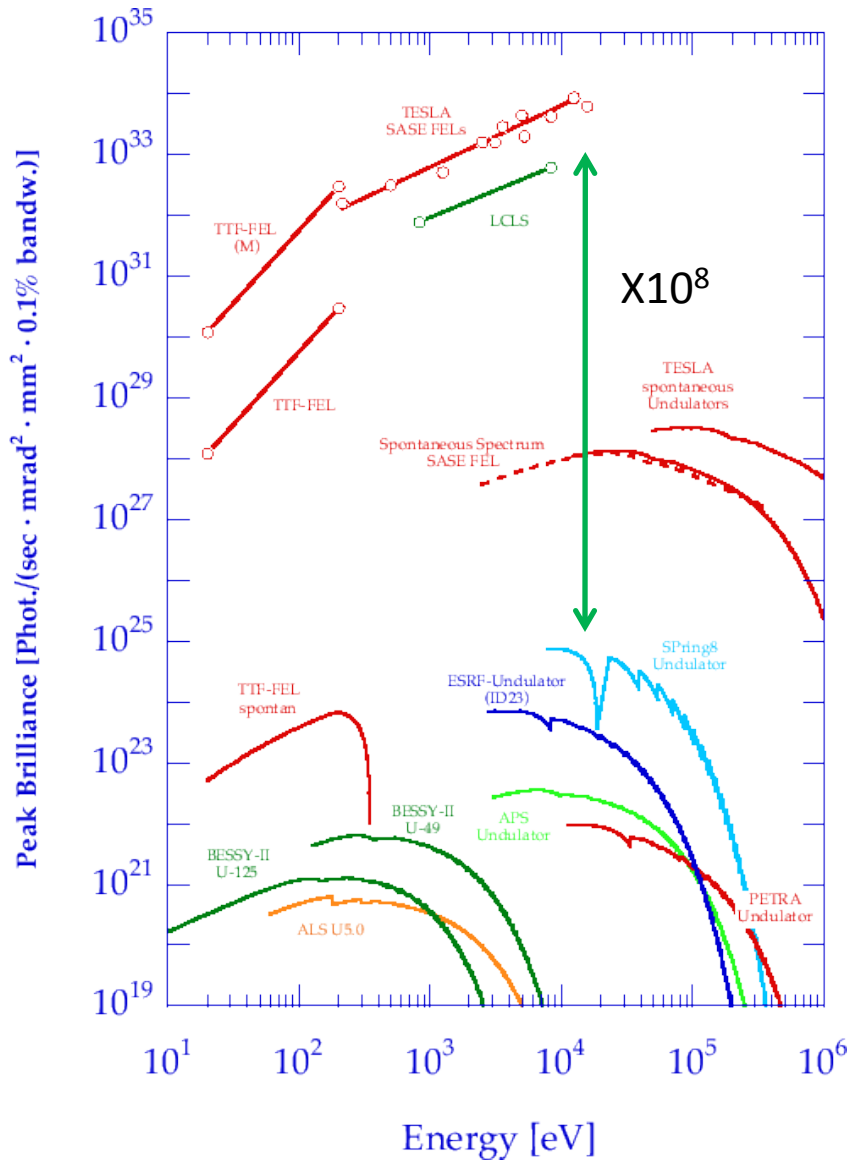

$$\lambda_p = \frac{\lambda_u}{2\gamma^2} \left[ 1 + \frac{K^2}{2} \right]$$

# Undulators for XFELs

$$K = \frac{eB\lambda_u}{2\pi m_e c}$$

- Alternating magnetic field, wavelength of a few cm.
  - Shorter wavelength allows operation with lower energy electron beams (if they have enough brightness)
  - Short wavelength undulators require narrow gaps -> alignment and wakefield problems
- For XFELs, generally want as high a “K” as practical
  - Provides higher gain and efficiency
  - High K -> higher e-beam energy
- Very tight tolerances: ~10 micron orbit in LCLS

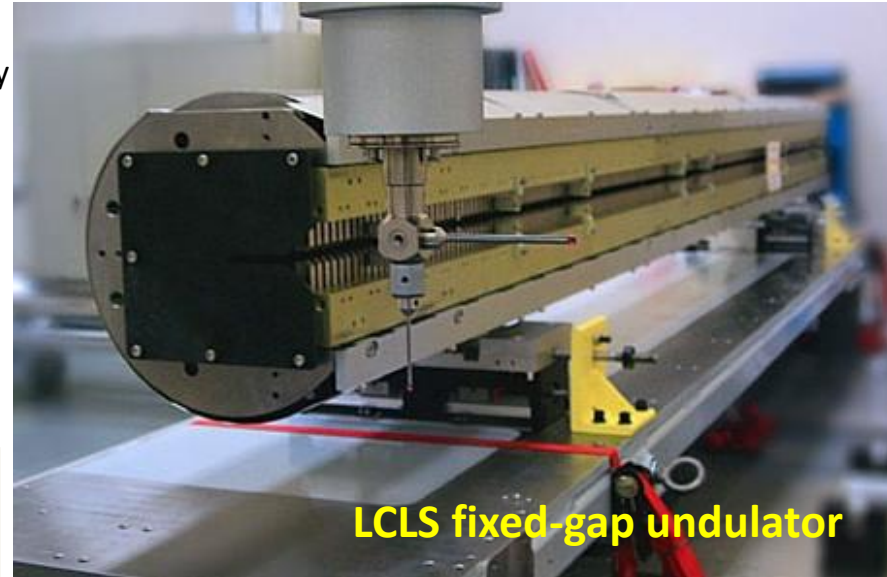

LCLS fixed-gap undulator

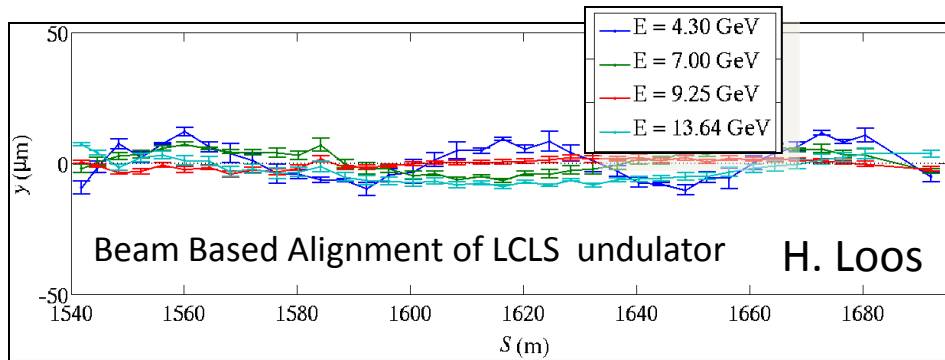

LCLS\_II Test variable gap undulator

Fixed Gap Undulator: Simple, high fields, good tolerances. Need to change beam energy to change wavelength

Adjustable gap Undulator: Can change wavelength with fixed e-beam energy: allows multiple undulators fed from a single linac.

# LCLS Undulator $\sim 130$ M long



$\sim 10$  micron trajectory straightness!

# Gain, Saturation and Taper

LCLS Gain at max energy (10 KeV)

=4.16+-0.11m,Und:1to32,15.09GeV,Xcorr-YagX,GainLength---2009-12-18-21

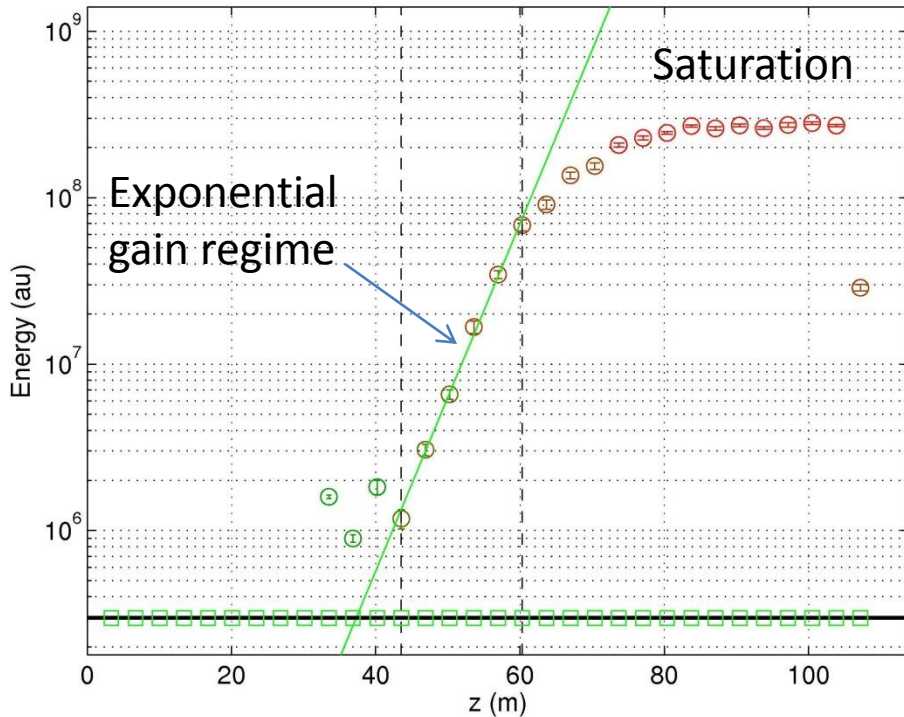

LCLS undulator has pole “cant” that allows small field adjustments

Taper increases saturation power 2X

Gain saturates because so much energy is extracted from the electron beam that it falls out of phase with the X-rays and no longer generates power

Can “taper” undulator fields: Lower K results in lower resonant E-beam energy. Adjust gap along the length of the undulator.

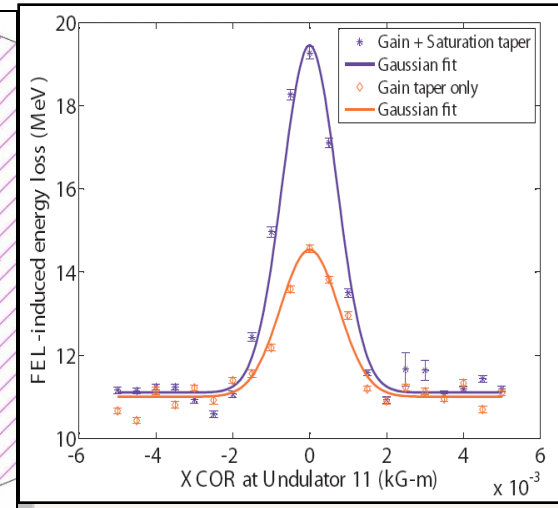
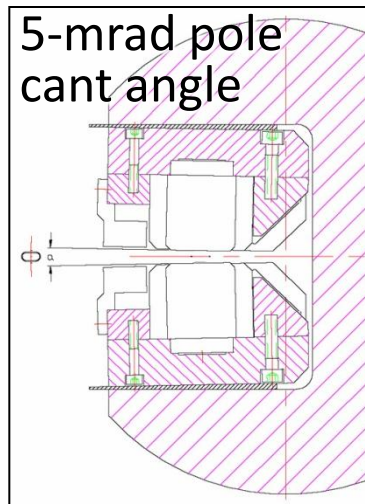

# SASE FEL pulse structure

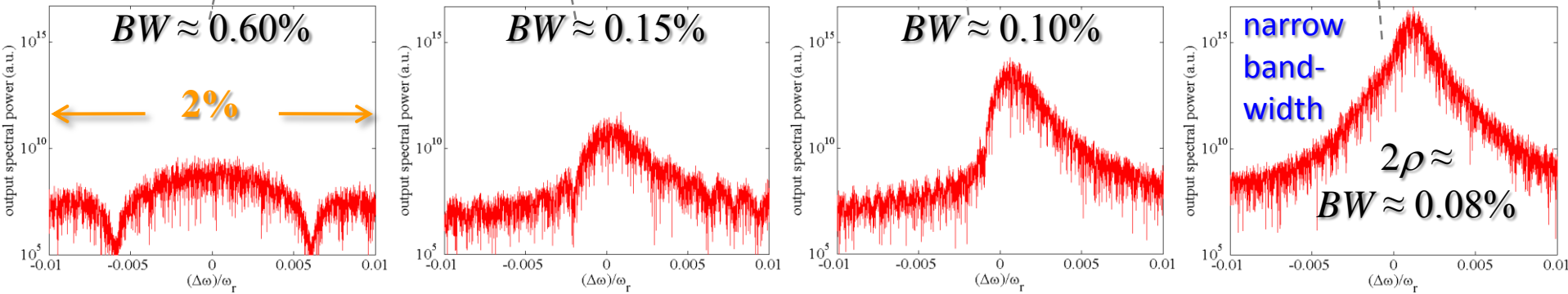
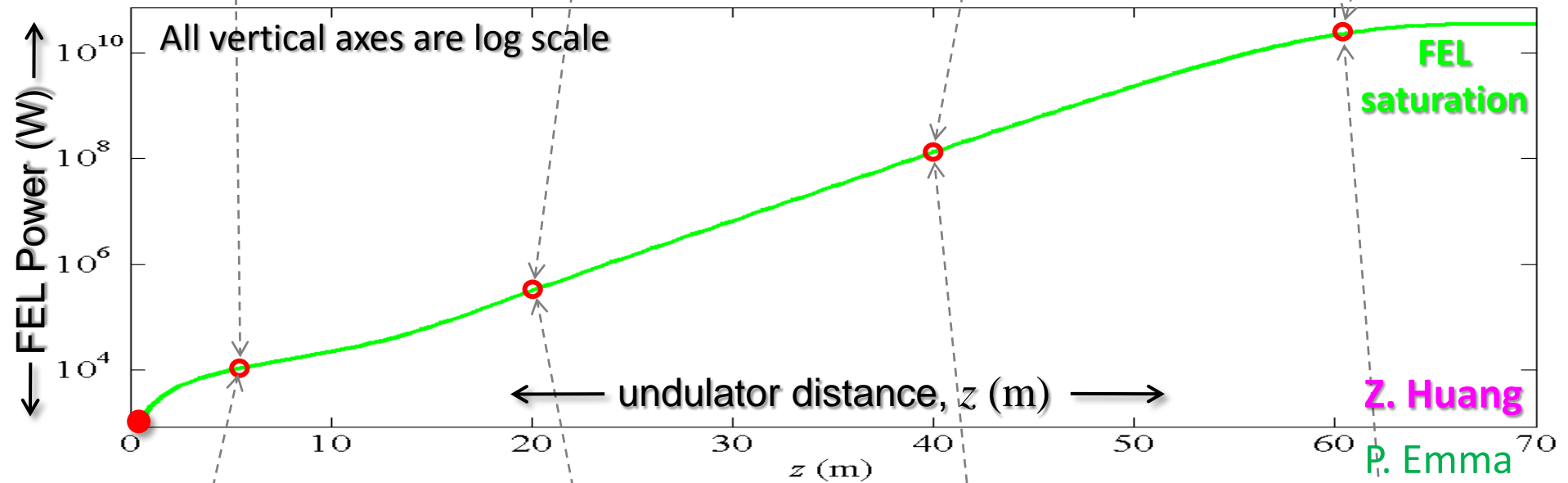
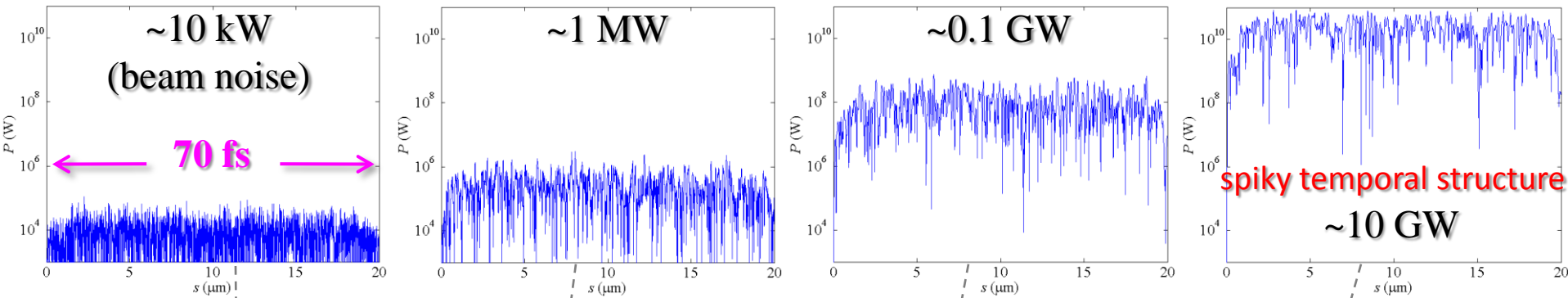



# Seeding

- **FEL light is amplified noise:** 10-100X transform limited bandwidth.
- Would like to generate low power, narrow band seed light, then amplify in the undulator.
  - Allows control of bandwidth, pulse length etc.
- **Difficult:** seed needs ~MW peak power in narrow band, tunable X-rays
- **Self Seeding:** Use a short undulator to generate spontaneous emission, then filter to generate seed
  - For hard X-rays can use Bragg diffraction from crystals.
  - For soft X-rays can use grazing incidence gratings
- **Laser seeding:** Generate high harmonics of a conventional laser
  - Direct generation of laser harmonics in a gas
  - Generation of harmonics in an undulator, then repeat (harmonic cascade)
  - ECHO harmonic generation (described later)
  - Laser seeding looks difficult for hard x-rays!
- Laser seeding experiments under way at DESY / FLASH (sFLASH), and Fermi ELETTRA. Self-seeding experiment planned at LCLS in fall 2011.
- Seeding provides a large improvement in the performance of XFELs, included at least as an option in all new designs.

# Self Seeding

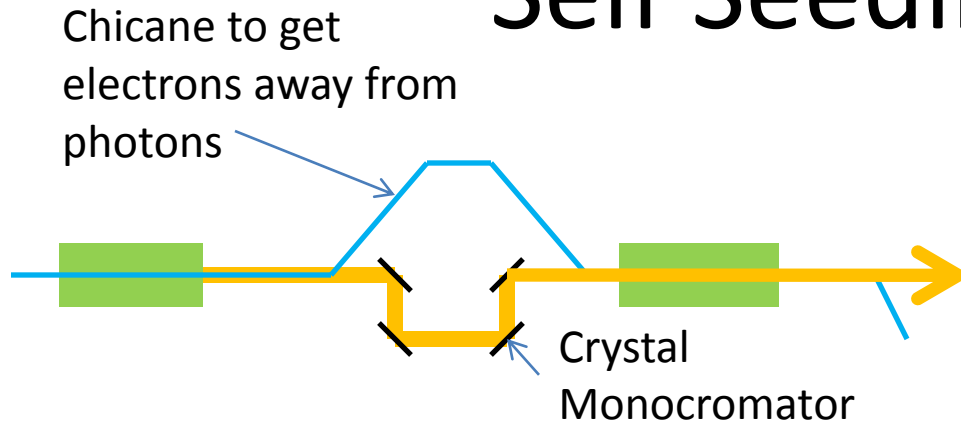

Works in concept, but chicane needs to be very long to get the same delay as the monochromator. (can't bend too far due to CSR).

Can use 2 bunches:

1<sup>st</sup> bunch generates seed light

2<sup>nd</sup> bunch timed to interact with seed light from 1<sup>st</sup> bunch in the second undulator

(Y. Ding, Z. Huang, R. Ruth)

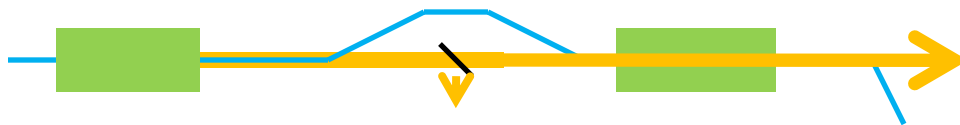

Single bunch self-seeding:

Short X-ray pulse passes through narrow band crystal "stop" filter

Filter rings for a few fs after the pulse

Bunch is delayed in a small chicane to be

timed with the ringing pulse.

(G. Geloni, V. Kocharyan, E. Saldin)

(G. Geloni, V. Kocharyan, E. Saldin)

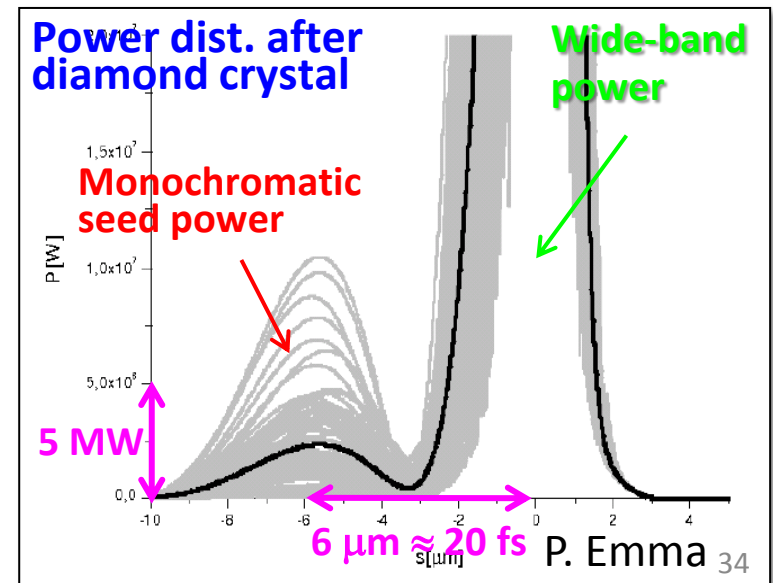

# Laser Seeding (ECHO)

Laser fundamental wavelength  $\sim 0.8\mu\text{m}$ . Need 1000X harmonic for soft X-rays, 10,000X harmonic for hard X-rays

Can generate  $\sim 4^{\text{th}}$  harmonic with high efficiency in non-linear crystals

Can generate up to  $\sim 100^{\text{th}}$  harmonic in gas discharge, but efficiency is poor.

ECHO seeding provides a method to generate high harmonics from a beam. (G. Stupakov)  
 Concept demonstrated at SLAC (X5 harmonic), (D. Xiang)

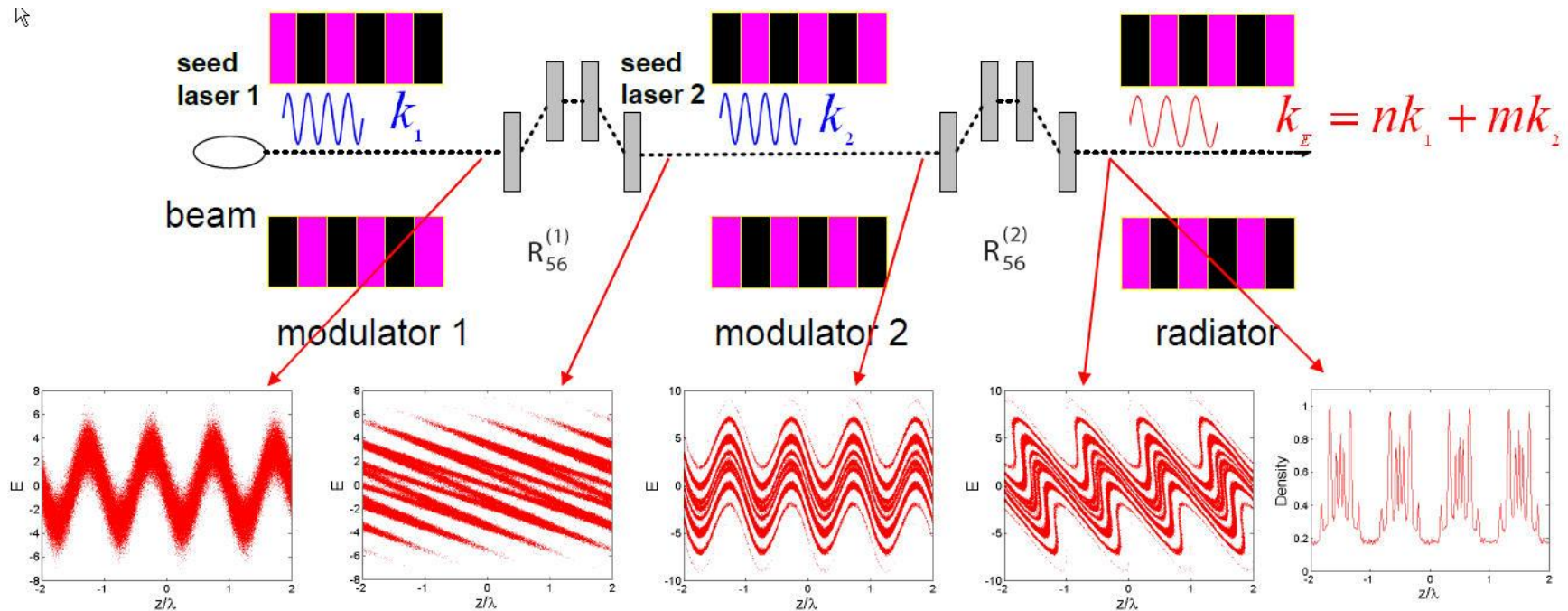

# Slippage and Pulse Lengths

- Slippage: Each undulator period the electrons slip by one wavelength relative to the X-rays.
  - A single electron would produce an X-ray pulse with the same number of wavelengths as are in the undulator.
  - Coherence length is the number of X-ray wavelengths in a  $\sim 2$  gain lengths,  $L_c < L_s$
  - Minimum X-ray pulse width  $\sim$  coherence length
    - For LCLS at 480eV, GL = 3M get 1.7fs
    - At 10 KeV get  $<100$ as, not a limit in the near future.

Maximum peak current  $\sim 3$ KA. For a typical 300pC bunch  $\rightarrow$  100fs pulse (typical for XFEL designs)

Can operate at 20pC  $\rightarrow$  7fs pulse.  
Can't directly measure, but have indirect evidence of  $<10$ fs operation at LCLS

10fs operation is now standard, with possibilities to go to  $\sim 1$ fs pulses (next talk).

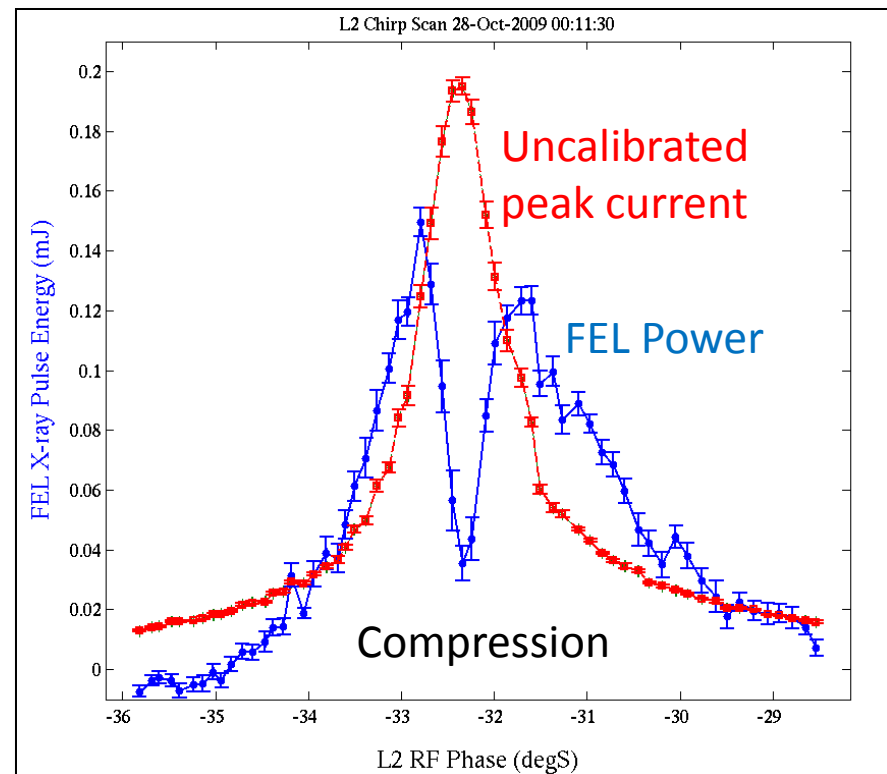

# Multi-User Capability

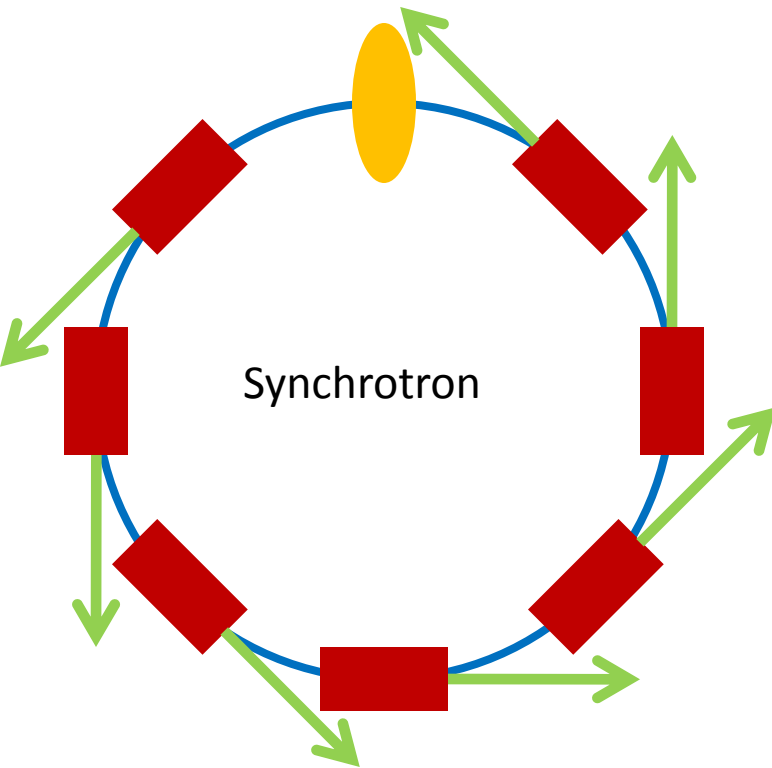

Synchrotron can support many beam lines

Incoherent undulator radiation included in equilibrium beam parameters.

Accelerator cavity restores energy lost to X-rays

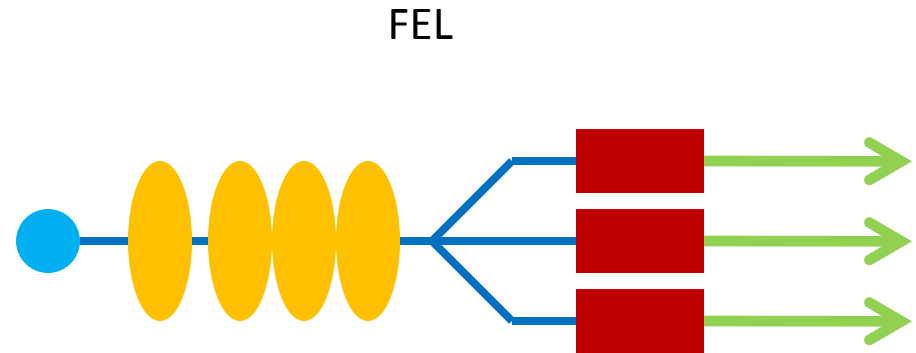

FEL interaction increases beam energy spread, cannot re-use beam

Can use fast magnet (kicker) to distribute a multi-bunch beam among multiple undulators

Accelerator magnets cannot change quickly, so need to run all bunches at very similar energy -> adjustable gap undulators for tuning.

# FEL Facilities

- DESY / TTF->FLASH: (2000)
  - Superconducting LINAC,  $\sim 1.2$  GeV,  $1000\text{\AA}$  ->  $41\text{\AA}$
- SLAC / LCLS (2007):
  - Room Temperature LINAC, 15 GeV  $25\text{\AA}$  ->  $1.2\text{\AA}$
- Trieste / FERMI (2010):
  - Room Temperature LINAC, 1.2 GeV  $1000\text{\AA}$  -  $100\text{\AA}$  (planned)
- Spring-8 SACLA (2011)
  - Room Temperature LINAC, C-band, 8 GeV  $1.2\text{\AA}$  -> ( $0.8\text{\AA}$  planned)
- DESY / European-XFEL (est 2015)
  - Superconducting LINAC, 17.5) GeV,  $1\text{\AA}$  –  $60\text{\AA}$

## Proposed / Funded (Parameters and schedule subject to change)

- Pohang XFEL ( $\sim 2015$ )
  - Room Temperature 10 GeV LINAC
  - $0.6\text{\AA}$  to  $50\text{\AA}$  (planned)
- PSI Swiss-FEL ( $\sim 2016$ )
  - Room Temperature 6 GeV LINAC (C-band)
  - $1\text{\AA}$  -  $70\text{\AA}$
- Shanghai XFEL (?)
  - Room temperature LINAC, 6 GeV  $\sim 1\text{\AA}$
- SLAC LCLS\_II (2017)
  - Room Temperature LINAC 14 GeV  $50\text{\AA}$ -  $1\text{\AA}$
- LBNL NGLS (2020s)
  - CW superconducting LINAC, 2 GeV,  $50\text{\AA}$ -  $10\text{\AA}$
- LANL MaRIE (2020s)
  - Room Temperature LINAC,  $0.25\text{\AA}$

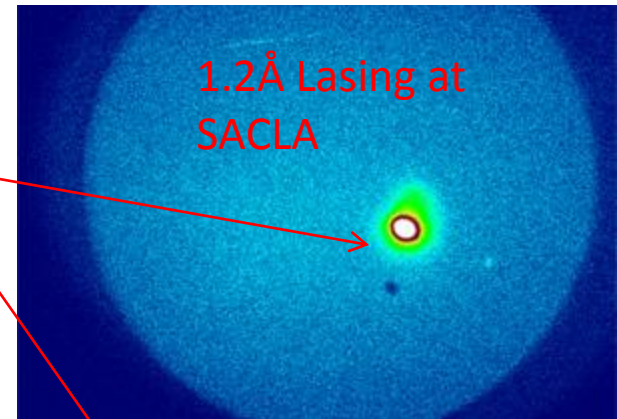

# Future Light X-ray Sources

- Most development work is on FELs.
- More simultaneous users to reduce beam-time costs
  - LCLS, SACLA are single user
  - European XFEL: 3 undulators to support simultaneous users.
- Shorter Wavelength to open new science possibilities
  - LCLS and SACLA both 1.2Å
  - SACLA expects 0.8Å
  - LANL MaRIE ~0.25Å
- Narrower Linewidth to improve monochromator throughput.
  - LCLS operates at ~0.2% bandwidth
  - Seeding expected to reduce bandwidth X10-X100 for future FELs
- Shorter pulse duration for better time resolution measurements
  - LCLS: <10fs
- Higher repetition rate to reduce experiment time.
  - LCLS: 120Hz, SACLA 100Hz.
  - European XFEL: 30 KHz (10 Hz X 3000 Bunches)
- Higher Peak Power for nonlinear and single-shot imaging experiments.
  - LCLS maximum is ~70GW.

# Short Wavelength Limits

- Emission wavelength scales as  $\gamma^2$ , but gain tends to decrease with wavelength.
- Above  $\sim 20$  KeV, an additional effect decreases FEL gain: The energy spread from statistics in spontaneous emission increases the beam energy spread and reduces the gain further.
- For LCLS beam parameters, 25 KeV seems practical
- Design studies with low emittance beams suggest energies up to  $\sim 100$  KeV may be possible.
- High energy X-rays put tight constraints on beam brightness and undulator quality

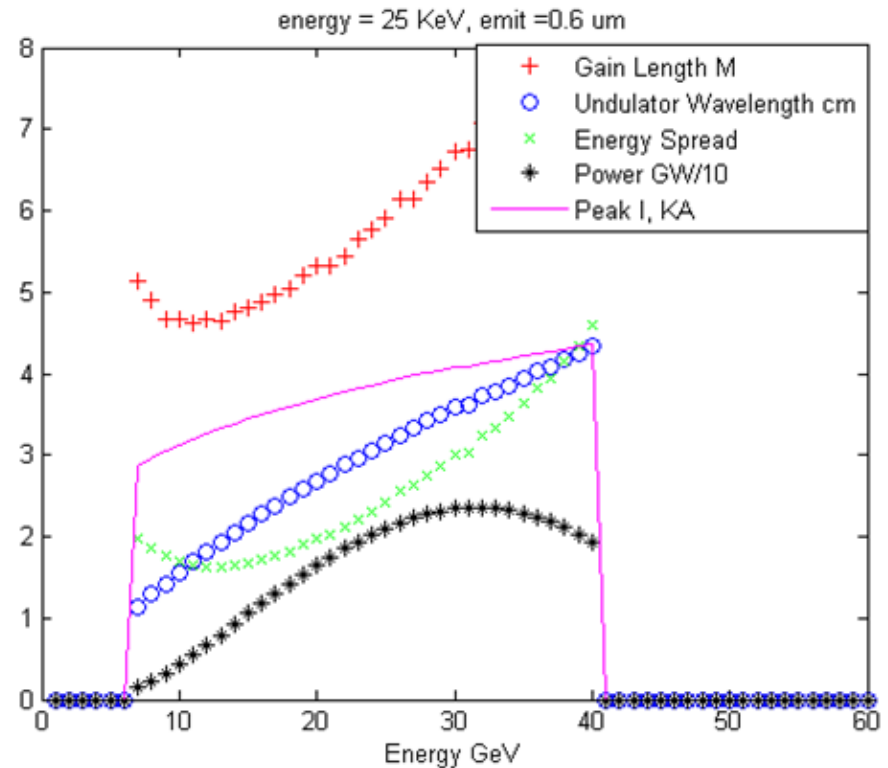

Calculated gain length and power for 25KeV FEL using LCLS like beam parameters

FELs above 25 KeV are likely to be very large facilities,  
need to understand the science case



# Recirculating LINAC

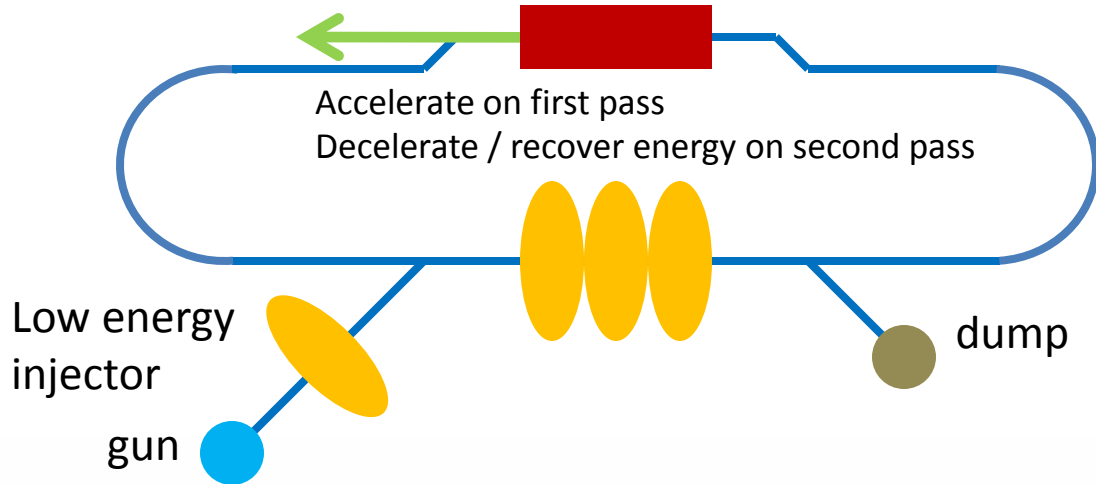

Superconducting LINAC, usually operating CW mode

Energy recovery from beam allows much higher average current than for a single-pass linac.

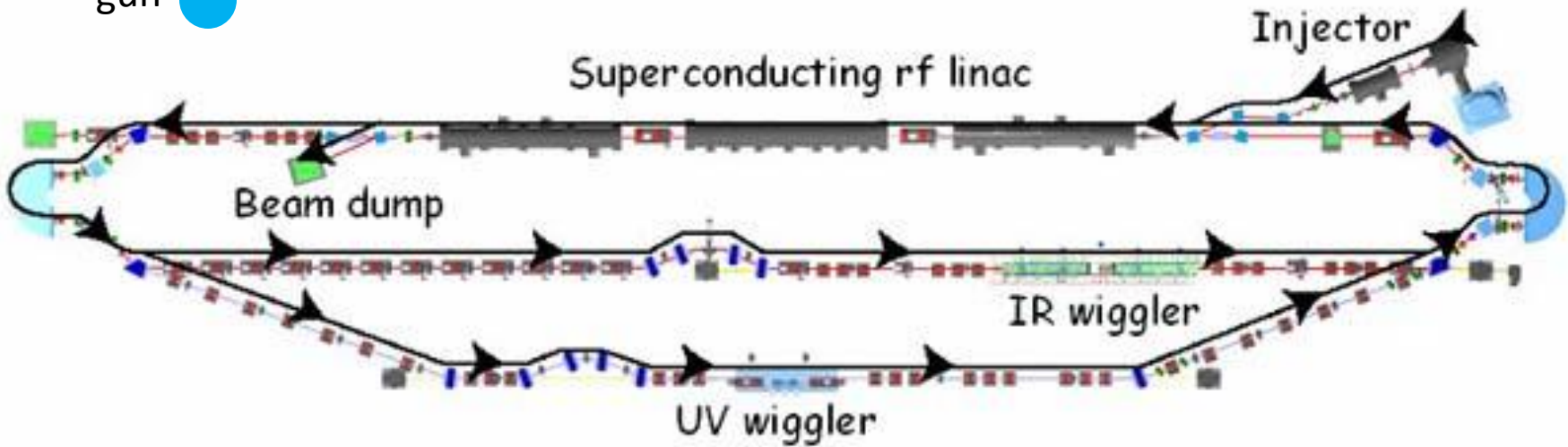

FEL at TJNAL produces 14KW at 1.6um, 1KW at 250nm

**For an XFEL, Beam Dynamics issues with 2 very different energy beams in the same linac are challenging!**

# XFEL Oscillator

- Existing FELs far from transform limit.
- IR – UV FELs operate as oscillators – can this be extended to X-rays?
- Use Bragg crystals as mirrors
- Be Lens to focus
- Expect 1MHz beam, 1ps pulses, 20MW peak,  $1.5 \times 10^{-7}$  Bandwidth.
- Cavity design / alignment is challenging

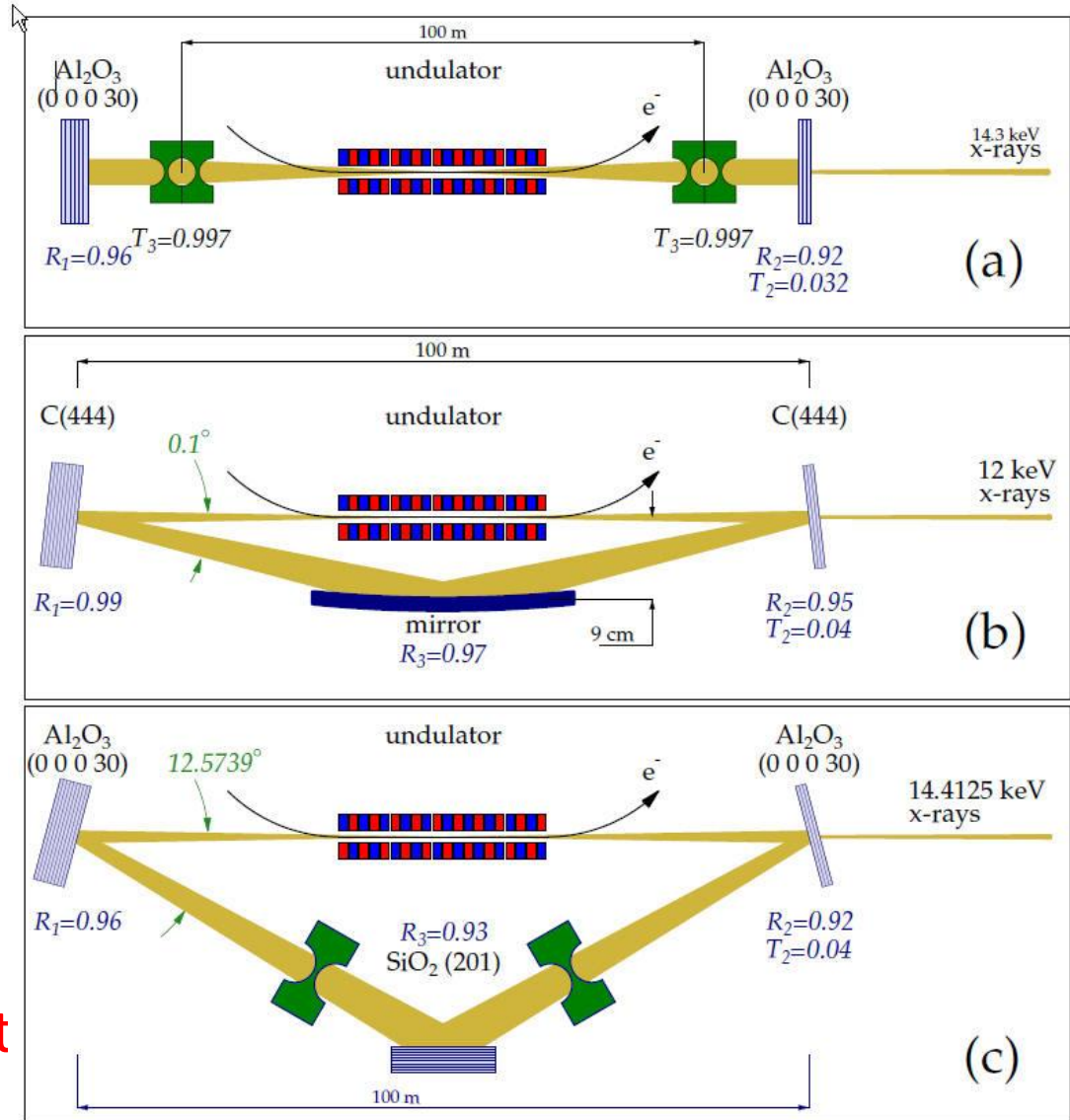

Kwang-Je Kim, Yuri Shvyd'ko, Sven Reiche  
ANL-AAI-PUB-2008-04

# Attosecond FELs

- Operation at low charge (20pC) allows compression to <10fs pulses at LCLS
- Operation at 1pC should produce a very bright electron beam, and may allow ~1fs X-rays.
  - Some issues with electron beam diagnostics

Various laser modulation techniques to go even shorter:

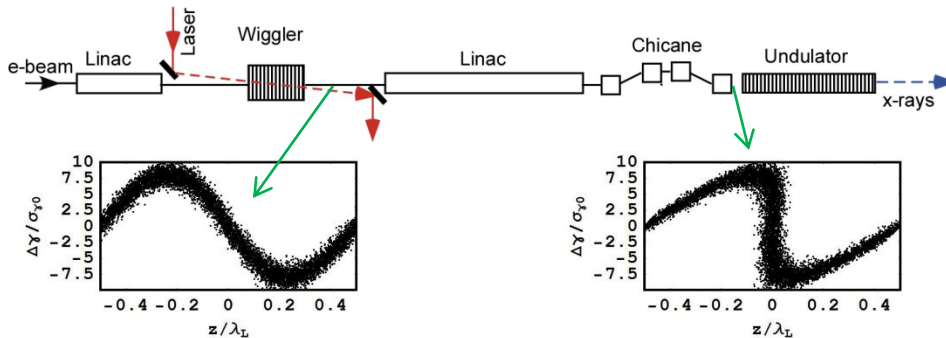

Bunch length limited by coherence length

At LCLS for 10 KeV, this is about 100aS

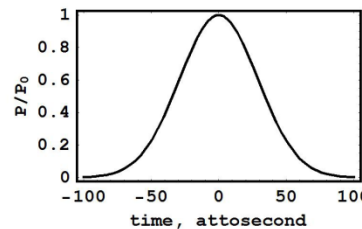

70 aS output pulse!

Peak power is still limited, so not very many photons in a short pulse

No clear path to even shorter pulses.

A. Zholents and G.  
Penn, Phys. Rev. ST AB  
8(2005)050704

Images from E. Saldin,  
E. Schneidmiller, M. Yurkov

# High peak power FELs

Many experiments require high peak power, above the ~10s of GW from present FELs.

Single molecule imaging would like ~2TW in a 100nm focus to allow alignment of images. (Need < 20fs pulse before molecule explodes).

Scheme devised by  
G. Geloni, V. Kocharyan, E. Saldin

A seeded beam can make much more efficient use of a tapered undulator: All electrons see similar fields

TW power levels possible

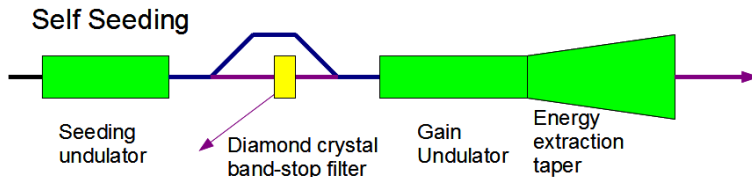

With ambitious parameters, (.2um emittance), simulations at 15 GeV give 4TW in 240M undulator

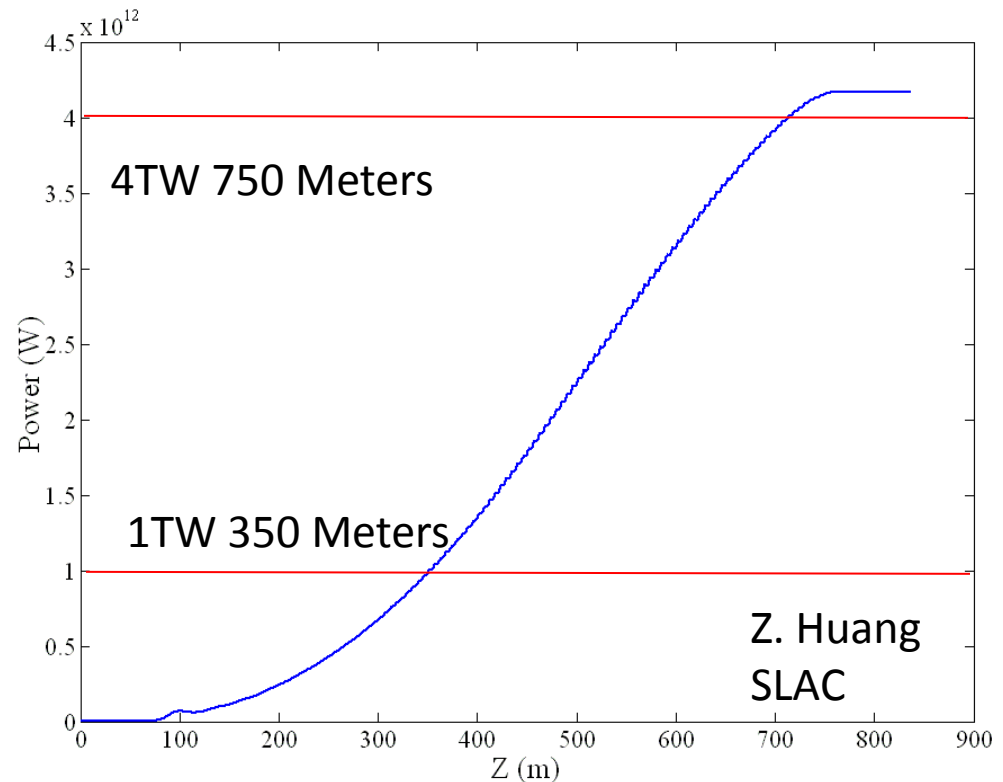

Use Genesis to simulate  
27 GeV, 5KA, (2/3 SLAC linac) 0.6um Emittance  
Very conservative parameters



# BELLA (Berkeley Lab Laser Accelerator)

Bldg 71 at LBNL

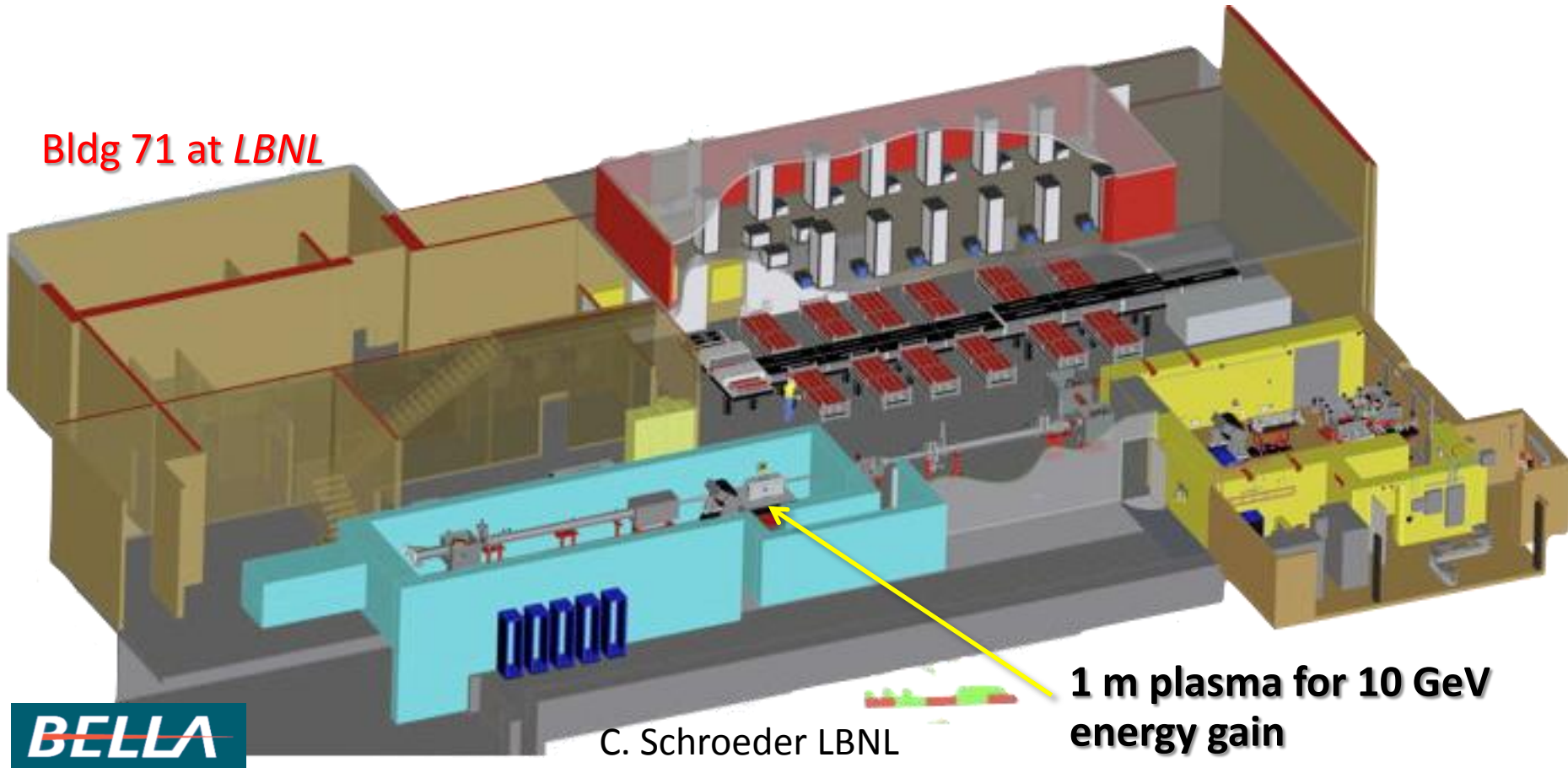

Compact, but not tiny.....

# What isn't covered here:

- **Almost everything!**
- Synchrotron light sources are used for the great majority of X-ray science today.
  - Only had a few viewgraphs here
- A wide variety of other accelerator / X-ray source types
  - High rep-rate RT linacs, laser backscatter sources, laser / synchrotron slicing sources, RF undulators, etc.
- Precision beam manipulation: Pulse length control, polarization control, bandwidth control etc.
  - All valuable for experiments
- Noise, backgrounds, harmonics, pulse stability, etc
  - Critical for the design of experiments
- X-ray systems: Diagnostics, mirrors, stoppers, etc.
- Costs: These are 200M€ to >1000M€ machines
  - Different types of machines may have very different construction and operating costs.

# What to take from this:

- There are a variety of possible X-ray sources with a wide (but correlated) range of operating parameters.
- These are expensive facilities and their design should be driven by the science requirements, but the scientists need to know what to ask for.
- X-ray scientists need to understand the capabilities and limitations of the machine designs in order to know what is reasonable and what isn't.

When an experiment is running you don't want to hear: "Wow, you can do that!"

Or worse

"What do you mean you can't do that?!"



# Discussion

- Imagine you want to do single-molecule imaging at  $1\text{\AA}$ , 20fs pulses. You will be measuring the X-ray diffraction pattern on a series of CCD sensors. What type of facility would be appropriate?
  - Present day CCDs have a few-millisecond readout time. How would it change things if this were reduced to 100us, 10us, 1us, 100ns?
  - Does it matter if you have a gas or liquid jet to inject the samples into the chamber?
  - What would change if you could orient the molecules before injection?
- What sort of system would be appropriate for a soft X-ray source for production semiconductor lithography.
  - What sort of additional information is needed